



Dunbier
for boat trailers

PARTS & ACCESSORIES 2023/2024



SCAN TO
DOWNLOAD

WWW.DUNBIER.COM



Dunbier

for boat trailers



Dunbier boat trailers are a big part of Australia's boating history. Manufacturing more boat trailers than any other brand in the marine industry, means servicing and maintaining Dunbier trailers has evolved into a full time opportunity for many marine and specialist dealers across the country.

From humble beginnings over 50 years ago, the Dunbier name has grown to be one of the most trusted brands of boat trailers anywhere in the world.

Founded by Russell Dunbier in a small single bay Melbourne factory, family owned and operated Dunbier Marine Products now incorporates a state-of-the-art manufacturing facility in Braeside, Victoria, branch offices in Brisbane, Sydney, Adelaide and Perth, and employs over 70 hard working Australians across the country.

The Dunbier range of trailers has evolved and to this day we have the widest range of highly advanced products of any trailer manufacturer bar none. We can provide you with the right choice to suit not only your boat, ski or kayak, but also the type of boating you enjoy.

Our nationwide dealer retail network is the backbone of our business and you can be assured that wherever you see the Dunbier name you will be provided with the best possible service and knowledge in the marine industry.

As part of our commitment to our customers we manufacture and supply a comprehensive range of spare parts so that your Dunbier trailer can be maintained to the highest standards. With everything from replacement frame sections to consumer driven retail products, there is a Dunbier part for you.

We hope you find exactly what you are looking for in our range and look forward to you experiencing the Dunbier Difference like so many before you.

At Dunbier we believe that a day spent on the water is one of the best days you can have and we are proud that we can help to make those memories for so many Australians.

The Dunbier Family



MELBOURNE, VIC

03 9580 2455

SALES@DUNBIER.COM



BRISBANE, QLD

07 5540 7477

DUNQLD@DUNBIER.COM



ADELAIDE, SA

08 8250 4557

DUNBSA@DUNBIER.COM



SYDNEY, NSW

02 9618 0100

DUNBSW@DUNBIER.COM



PERTH, WA

08 9437 9689

DUNBWA@DUNBIER.COM



SCAN THE QR CODE TO VISIT THE WEBSITE AND
DOWNLOAD A PDF VERSION OF THIS CATALOGUE.

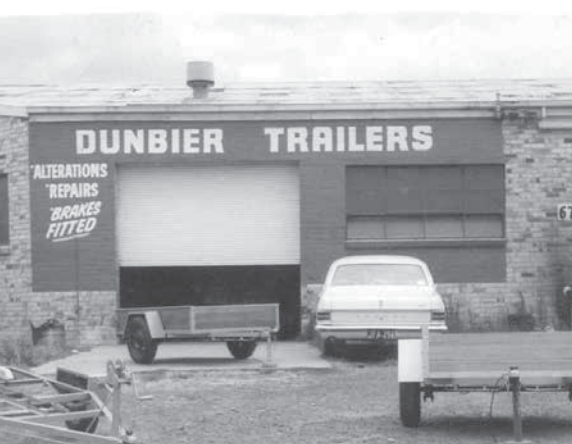



Spare parts are a necessity for every consumer and major retailers across the country, specialising in maximising the opportunity for the benefit of the customer.

The Dunbier line up of spare parts and accessories has been developed to ensure the investment in your chandlery is well worth while.

With a proven track record of boosting sales by up to 25%, it will maximise your profit, increase customer satisfaction, drive workshop sales & increase your customer return opportunity.

Speak to your State Sales Manager to find out how you can join the program today.

WHAT'S ON OFFER?

The Dunbier Retail Program is simple and with 1-7 bay standard layouts available, it caters to all types of retailer.

Choose from a 1-7 bay standard layout to receive:

- Additional store fill parts discounts
- Gondola Shelving units
- In-store signage
- Re-order tags
- Assistance setting up initial layout and establishing a re-order system
- **Increased profits and happy customers**



THE OPTIONS

ESSENTIALS - 1 BAY

The minimum requirement for all Dunbier trailer dealers, incorporating key service and retail consumable parts.

UPGRADES - 4 BAY

Maximise your stores potential with a broad range of service, retail, upgrade and maintenance parts and accessories. Covering hardware, rollers, suspension and accessories, it is a premium level of the Dunbier retail program.

VALUE-ADD - 2 BAY

Extend your key service items with fast moving high volume retail parts.

RE-FURB - 5 BAY

Position your store as the go-to destination for boat trailer refurbishment. With a wide range of options, you can confidently meet the demands of your customers who are refurbishing their trailer.

SERVICE OFFER - 3 BAY

Deliver increased profits and a broader consumable offering for your customers in-store.

REPAIR - 6 OR 7 BAY

Be prepared with stock of our most popular and essential products, ensuring you have what your customers require, when they need it most.

SPEAK TO YOUR STATE SALES MANAGER TODAY TO ENROLL IN THE PROGRAM OR TO FIND OUT HOW TO MAXIMISE YOUR PARTS AND SERVICE OPPORTUNITIES.

BEST SELLERS - FOLDING TRAILER & PACK RACK

COMPLIANT WITH AUSTRALIAN ROAD REGISTRATION REQUIREMENTS

- ✓ UNIQUE DESIGN ASSEMBLES IN UNDER 30 MIN
- ✓ PACKED WEIGHT OF JUST 45KG FOR EASY STORAGE
- ✓ CAPABLE OF TOWING A BOAT UP TO 3.8M & 205KG



* Folding trailer should be used for short trips not exceeding 60km/hour. Refer to the website for more information.

ALLOY FOLDING TRAILER

Manufactured with an ultralight "All Alloy" frame and winch post, the folding trailer is an absolute innovation for cartoppers, caravanners or anyone short on storage space.

A perfect solution for car toppers and tinnies, the folding trailer can be assembled within 30min of arriving at your destination and simply unhooked at the end of the day.

The kit is supplied with everything you require (excluding tools) and includes an L.E.D. lightboard and VIN plate that is affixed to the frame.

FOLDING TRAILER

3,600 mm overall length, 1,360mm overall width, 45kg tare weight, 250kg gross trailer mass.

Comes packed in display crate # 9001-A

STANDARD FEATURES

- Full size hubs & bearings
- Premium winch with strap
- Steel wheels with high speed radial tyres
- Mudguards as standard
- Heavy duty tie down points
- All bolts and lock pins provided
- LED lightboard included (not shown)

DUNBIER PACK RACK

When heading away with your tinnie or jet-ski storage space is often at a premium. The pack rack provides a simple solution to getting all your gear to the beach or bank. Manufactured from galvanised steel, it can store up to 150kg of additional gear and is perfect for watersports and camping gear. It's convenient, safe and easy to install, and is the perfect storage option when traveling or at home in the garage.

150kg capacity, galvanised steel construction.

Bolts to trailer

9733



- GALVANISED STEEL CONSTRUCTION
- 150KG CAPACITY
- EASY TO INSTALL

* Image used for display purposes only. Trailer not included.



ALPHABETICAL INDEX

A

Adaptor Plugs	22
AL-KO® Brake Actuator	34
Alloy Folding Trailer	4
Alloy Wheels	24
Axle Nuts & Washers	28
Axle Saddles	32
Axles	35-36

B

Beach Launcher Spare Wheel Carrier	25
Bearing Grease	29
Bearing Protector Covers	27
Bearing Protectors	27
Bearing Sets	28
Bolts	40
Bow Rollers	41
Brake Actuator	34
Brake Cable	33
Brake Cable Clamps	33
Brake Calipers	30
Brake Actuator Replacement Parts	34
Brake Coupling Master Cylinder	33
Brake Line Replacement Parts	32-33
Brake Lines & Kits	32
Brake Pads	31
Bumper Blocks	46

C

Cable Ties	22
Caliper Replacement Parts	31
Calipers	30
Coupling Lock	16 & 49
Couplings	16-17
Cross Member Stops & Plates	38
Cross Members	38-39

D

Decals	51
D-shackles	15
Dunbier Winches	18
Dunbier Jockey Wheels	15-16

F

Folding Trailer	4
Fulton Jockey Wheel Replacement Parts	15
Fulton Winch	18

G

Glider Kits	49
Guide Poles	51
Grease	29

H

Hub in a Tub Complete Hub Replacement Kit	29
Hub Replacement Kit	29

J

Jerry Can Holder	51
Jockey Wheel Replacement Parts	15-16
Jockey Wheels	15-16

K

Kayak Carry Bars	51
Keel Support - Kayaks	38
Knott Jockey Wheel	15
Knott Jockey Wheel Replacement Parts	15

L

L&R Boat Latch Adaptor Plates	51
L.E.D. Lights	20
Light Kits	20
Lighting Replacement Parts	21
Light Cover	21
License Plate Bracket	21

M

Mechanical Brake Conversion Kit	32
Mechanical Handbrake Assembly	33
Mount Bracket for Jockey Wheel	15
Mudflaps	25
Mudguard Carriers	26
Mudguards	26

N

Number Plate Bracket	21
Nuts	40

O

Outboard Motor Supports	51
-------------------------	----

P

Pack Rack	4
Pad Brackets	47-48
Pads	46, 49
Parallel Members	39
Parallel Rollers	41-42
P-clips	22
Primal Rims & Tyres	24
Puma Rims & Tyres	24

R

Rail Mount Kit	37
Ratchet Tie-downs	50
R-clips	48
Reflectors	21
Rims & Tyres	23-24
Rims & Tyres - 13"	23
Rims & Tyres - 15"	24
Rims & Tyres - Puma	24
Roller Assembly Kits	44
Roller Brackets	43
Rollers	41-43

S

Safety Chain	48
Self Centring Systems	49
Shackle Bushes & Bolts	37
Side Marker Lights	20
Slide Brackets	47
Spare Wheel Carriers	25
Spare Wheel Covers	25, 49
Split Pins	28, 41
Spring Kits	36
Springs & Components	36-37
Stickers	51
Stub Axles	32
Supa Rolla Assemblies	39
Swing Drawbar D.I.Y.	38

T

Tie-down Straps & Mounts	50
Tie-downs	50
Tow Balls	17
Trailer Plugs	21-22
Two Hole Plate	48
Tyres & Wheels	23-24

U

U-bolts	40
U-brackets	47

V

V-blocks	41
----------	----

W

Walkways	38
Washers	40
Wheel Accessories	25, 49
Wheel Chocks	25, 49
Wheel Clamp	25, 49
Wheel Hub Seals	27
Wheel Hubs	29-30
Wheel Nuts	26
Wheel Studs	28
Wheel Stud & Nut Kits	28
Wheels & Tyres	23-24
Winches	18
Winch Carriers	19
Winch Handles	17
Winch Post Caps	19
Winch Posts	19
Winch Straps	17
Wobble Rollers & Components	41

PART NUMBER TO PAGE INDEX



PART #	PAGE #
1000	16
1010	16
1011	16
1014	17
1018	48
1019	48
1020	48
1021	48
1022	48
1023	17
1029	17
1030	17
1041	16
1045	16
1061	17
1090	33
1093	33
1094	33
1096	33
1161	18
1176	18
1192	17
1194	17
1200	17
1210	17
1262	15
1280	15
1286	15
1290	16
1291	15
1292	15
1293	15
1294	15
1295	15
1296	15
1298	15
1312	16
1350	16
1352	16
1353	15
1354	15
1355	15
1356	15
1360	16, 48
1361	15
1393	24
1394	24
1395	24
1396	24
1397	24
1400	23
1430	24
1431	24
1432	24
1433	24
1435	24
1436	24
1437	24
1438	24
1439	24
1449	23
1464	23
1466	23
1467	23
1468	24
1469	23
1470	24
1472	24
1480	24
1482	24
1484	24
1487	24
1488	24
1489	26
1491	23
1492	23
1493	24
1498	24
1499	24
1500	24
1507	24
1509	24
1512	24
1516	25

PART #	PAGE #
1517	25
1518	25
1519	25
1520	25, 49
1521	25, 49
1522	16, 49
1524	25, 49
1525	25
1531	25
1532	25
1534	25, 49
1536	51
1591	35
1592	36
1593	36
1594	36
1595	36
1596	36
1597	36
1598	36
1599	36
1600	36
1610	35
1611	35
1614	35
1615	35
1616	35
1617	35
1620	32
1621	32
1623	36
1624	36
1625	36
1626	36
1630	32
1631	32
1632	36
1649	29
1652	29
1653	29
1665	29
1666	29
1668	29
1669	26
1670	26
1673	28
1674	28
1677	41
1678	41
1679	41
1680	28
1681	28
1705	27
1706	27
1708	28
1710	27
1712	28
1716	27
1717	27
1718	27
1719	27
1740	27
1778	27
1779	27
1780	27
1781	27
1782	27
1831	29
1832	29
1840	33
1841	33
1845	33
1850	32
1860	33
1870	33
1880	33
1881	33
1886	32
1887	32
1890	32
1891	32
1892	32
1893	32
1894	32

PART #	PAGE #
1895	32
1896	32
1897	32
1898	32
1899	32
1900	32
1901	32
1909	30
1912	29
1918	30
1919	30
1920	30
1921	30
1922	30
1923	30
1924	30
1925	30
1926	30
1927	31
1928	31
1929	31
1930	31
1933	31
1941	34
1945	34
1946	34
1947	34
1953	31
1954	31
1955	31
1956	30
1958	31
1970	31
1971	30
1972	33
1973	33
1974	33
1976	33
1977	33
1979	33
2008	37
2012	37
2014	37
2015	37
2016	37
2017	37
2018	37
2019	37
2020	37
2021	37
2022	37
2023	37
2030	37
2040	37
2050	37
2121	40
2192	40
2193	40
2194	40
2195	40
2196	40
2197	40
2199	40
2213	40
2214	40
2216	40
2225	25
2238	26
2240	26
2260	26
2355	26
2356	26
2357	26
2358	26
2361	26
2362	26
2363	26
2364	26
2380	26
2390	26
2451	20
2452	20
2453	20
2455	20

PART #	PAGE #
2479	20
2481	20
2482	20
2496	21
2497	21
2730	22
2740	22
2750	22
2751	22
2770	22
2810	22
2820	21
2830	21
2834	21
2835	21
2836	21
2837	21
2851	21
2852	21
2855	22
2871	22
2886	41
2887	41
2888	46
2890	46
2892	41
2893	41
2895	43
2897	42
2898	41
2899	42
2901	41
2902	41
2903	41
2904	46
2905	46
2907	43
2908	43
2909	42
2920	42
2923	42
2924	42
2925	42
2926	46
2932	42
2950	42
2960	42
2961	42
2962	43
2967	45
2968	41
2969	41
2975	41
2979	41
3021	42
3040	41
3044	44
3053	46
3054	46
3055	46
3060	45
3093	49
3100	44
3102	44
3103	44
3106	44
3108	49
3109	49
3110	44
3119	38
3120	38
3121	38
3122	47
3123	47
3124	47
3125	47
3131	48
3133	38
3135	44
3136	44
3139	47
3140	43
3141	43
3142	43

PART NUMBER TO PAGE INDEX

PART #	PAGE #
3143	43
3145	43
3146	43
3152	43
3153	43
3157	43
3160	51
3161	51
3162	43
3163	43
3231	43
3232	43
3233	43
3234	43
3235	43
3236	43
3237	43
3238	43
3239	43
3240	43
3250	47
3251	47
3252	47
3253	47
3254	47
3255	50
3256	50
3261	45
3291	48
3293	39
3294	39
3295	39
3297	39
3300	48
3304	47
3305	47
3306	47
3325	39
3326	39
3327	39
3328	39
3329	39
3330	45
3331	45
3332	45
3334	45
3335	45
3336	44
3337	44
3338	45
3339	45
3340	45
3341	38
3342	45
3343	39
3344	39
3345	39
3346	49
3352	46
3353	46
3354	46
3359	46
3365	46
3366	46
3367	46
3448	19
3449	19
3450	19
3451	19
3452	19
3453	19
3454	19
3456	19
3460	19
3463	19
3464	19
3466	19
3480	19
3490	19
3492	19
3499	19
3500	19
3915	51
3916	51

PART #	PAGE #
3920	51
3926	51
3927	51
3930	50
3931	50
3934	50
3937	50
3940	50
3945	38
3946	38
3950	50
3951	50
3954	38
3955	50
3957	50
3974	50
5630	48
5633	48
5672	48
7200	34
7201	34
7205	34
7207	34
8025	38
8026	38
8031	38
8032	38
8033	38
8035	38
8040	38
8045	38
8050	38
8066	38
8080	51
8103	51
8104	51
8105	51
8108	51
8113	51
8114	51
8890	40
8891	40
8892	40
8893	40
8901	40
8902	40
8903	40
8904	40
8905	40
8906	40
8907	40
8908	40
8909	40
8910	40
8911	40
8912	40
8913	40
8915	40
8916	40
8917	40
8918	40
8919	40
8920	40
8921	40
8922	40
8923	40
8924	40
8925	40
8926	40
8927	40
8928	40
8929	40
8930	40
8931	40
8932	40
8933	40
8934	40
8935	40
8936	40
8938	40
8939	40
8940	40
8941	40
8950	48

PART #	PAGE #
8957	40
8964	40
8974	48
8976	40
8999	48
9721	48
9727	48
9732	37
9733	4
31156	43
32360	45
1042C	16, 17
1044C	16
1160G	18
1161G	18
1162G	18
1163G	18
1280G	26
1354S	15
1360C	48
1549G	35
1550G	35
1562G	35
1563G	35
1568G	35
1569G	35
1570G	35
1571G	35
1576G	35
1577G	35
1582G	35
1583G	35
1588G	35
1589G	35
1592G	35
1602G	35
1603G	35
1606G	35
1607G	35
1608G	35
1609G	35
1612G	35
1618T	36
1620G	32
1620GC	32
1622C	28
1649F	29
1660C	26
1661C	26
1663S	28
1664S	28
1673S	28
1674S	28
1688S	28
1690S	28
1707S	28
1708A	28
1711S	28
1715B	27
1715S	27
1716S	27
1740P	27
1845G	32
1846G	32
1908G	29
1908SL	29
1912SL	29
1940IQ	34
1969P	31
2014K	36
2015K	36
2016K	36
2017K	36
2018K	36
2019K	36
2030G	37
2040G	37
2050G	37
2060C	37
2070C	37
2100B	40
2100S	40
2110B	40
2110S	40

PART #	PAGE #
2120B	40
2120S	40
2130B	40
2130S	40
2150B	40
2150S	40
2160B	40
2160S	40
2170B	40
2170S	40
2191B	40
2191S	40
2210B	40
2210S	40
2212B	40
2212S	40
2350L	26
2350R	26
2360L	26
2360R	26
2380B	26
2380G	26
2390B	26
2451S	21
2452S	21
2453S	21
2459S	20
2460S	20
2837SIG	34
2890B	46
2890G	46
2891B	46
2895G	43
2897G	42
2908BHD	42
2908D	42
2908G	42
2969D	41
2990B	43
2990S	42
3000B	41
3000S	41
3001B	42
3001S	42
3020B	41
3020S	41
3053G	46
3054G	46
3055B	46
3100SQ	44
3138B	47
3139G	47
3141L	43
3153S	43
3156H	43
3157H	43
3251L	47
3252S	47
3260S	45
3300L	48
3343W	39
3451HD	19
5630C	48
5632B	48
5632C	48
7202A	34
7202B	34
8962B	40
8963B	40
9001-A	4

BEST SELLERS - LIGHTING

LED TRAILER LIGHTS

The new 2023 series of L.E.D. lights are fully submersible, 12 volt powered, have a modern design and are backed by nationwide support. They're available as right/left lamp only, or in a kit including side markers and cables, both options shelf ready in upgraded display packaging.

All Dunbier L.E.D. lights have been tested to Australian standards and are Australian Design Rules approved.



FULLY SUBMERSIBLE

12 VOLT L.E.D.

MODERN DESIGN

NATIONWIDE SUPPORT



DUNBIER L.E.D. LIGHT KIT 8m - DISPLAY

Standard for most trailers - NEW model for 2023!
Left & right hand lamps, fully loomed, quick install.
Includes side markers.

Suits trailers up to 8m

NEW!

2459S



DUNBIER L.E.D. LEFT & RIGHT LIGHTS

Right & left hand lamps - NEW model for 2023!

Right & left hand lamps, inc. license plate lamp (Display Packed)

2460S

Left hand lamp only, inc. indicator, stop/tail (Sold individually, bulk pack)

#2453

Right hand lamp only, inc. indicator, stop/tail & license plate lamp (Sold individually, bulk pack)

#2455

NEW!

BEST SELLERS - WHEELS & TYRES



GALVANISED FOR MAXIMUM CORROSION RESISTANCE



TOUGH, RELIABLE, EASY TO INSTALL

WOULD YOU DRIVE A CAR WITH NO SPARE?

SPARE WHEEL CARRIERS

Tyre problems can quickly ruin your day on the water. It's important to be prepared by carrying a spare wheel that's compatible with your trailer.

Whether you prefer a simple U-bolt style or the convenient Beach Launcher Drop Down style, we have a variety of spare wheel carriers to suit your needs.



BEACH LAUNCHER DROP DOWN SPARE WHEEL CARRIER

Galvanised for corrosion protection, heavy duty spring bolt, complete spare hub and high quality bearings. Comes display packed.

Complete with Ford LM Bearings	# 1516
Complete with Ford Slim Line Bearings	# 1517
Complete with HT LM Bearings	# 1518
Complete with HT Slim Line Bearings	# 1519



SPARE WHEEL CARRIER - STANDARD

Suits Ford & Holden stud patterns / 13" or 14" wheels. Galvanised for corrosion protection & features flexible 3 position mounting: drawbar, winch post and side frame.

Complete as shown, in display packaging # 1532



SPARE WHEEL CARRIER - HEAVY DUTY

Suits Ford, Holden & L/C stud patterns, 13"/14"/15 wheels. Galvanised for corrosion protection & features flexible 3 position mounting: drawbar, winch post and side frame. Measures 260mm high x 225mm wide.

Complete as shown, in display packaging # 1531



SPARE WHEEL CARRIER - U-BOLT

Suitable for 13" & 14" wheels, flexible mounting options including drawbar, A-frame, winch post, rear bumper. Max. wheel weight 32kg.

Complete as shown, in display packaging # 1525



SPARE WHEEL COVERS

Back vinyl and white writing.

To suit 13" wheel	# 1520
To suit 14" wheel	# 1521

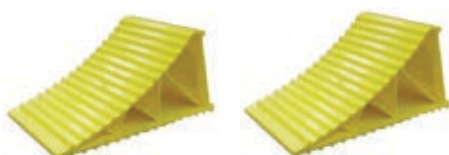

PLASTIC WHEEL CHOCKS

Easy to use and light for convenient storage. Sold in pairs.

Complete as shown # 1524

BEST SELLERS - HUBS

HUB IN A TUB COMPLETE HUB REPLACEMENT KIT

One of our most popular items, Hub In A Tub Includes everything you need to change a hub in an emergency - packed with grease, wheel hub, bearings, seals, grease caps and wheel nuts.

Suits Ford with LM series bearings	# 1665
Suits Ford with Slimline series bearings	# 1666
Suits HT Holden with LM series bearings	# 1667
Suits HT Holden with Slimline series bearings	# 1668

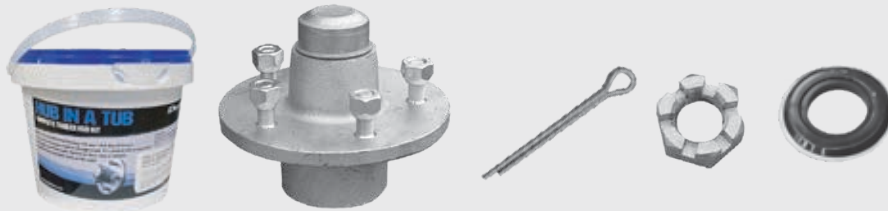

PACKED WITH GREASE &
READY TO GO!



“ I NEVER LEAVE HOME
WITHOUT ONE...
- DUNBIER AMBASSADOR
ANDREW 'ET' ETTINGSHAUSEN ”



BEARING PROTECTORS - DUNBIER - TO SUIT BRAKED & NON-BRAKED HUB

Suits braked and non-braked hubs with a 45mm internal snout dimension. PVC dust covers included.

Display packed, sold in pairs

1779



BEARING PROTECTORS - BEARING BUDDY®

Bearing Buddy®

Chrome plated, with stainless steel components.
Made in USA, packaged and sold in pairs.

To suit 50mm x 63mm 2 tonne axles
Bearing Buddy suits LM and SL hubs

1781

1780



BEARING PROTECTORS - TO SUIT TROJAN®

Suits TROJAN® 65mm square 2 tonne axles. Includes dust covers and sold in pairs.

Complete as shown

1778



WHEEL BEARING GREASE - FUCHS

FUCHS high temperature wheel bearing grease in a tub or cartridge.
Suitable for all type of trailers operating in extreme conditions.

500gm tub

1831

450gm cartridge

1832

BEST SELLERS - HUBS & BRAKES

✓ PERFECT FOR BEARING PROTECTORS & GREASE CAPS

✓ AVAILABLE IN FORD SL / HOLDEN LM & STANDARD OR MARINE SEAL

WHEEL BEARING SETS

SEE PAGE 28 FOR THE FULL RANGE OF BEARING SETS AVAILABLE.



BEARING SET - HOLDEN LM STANDARD SEAL

Suits all Dunbier trailers with 39mm rod & 40mm square axles.
Large Cup LM67010 & Cone LM67048
Small Cup LM11910 & Cone LM11949, Seal # 1710
Display packed

1690S



BEARING SET - HOLDEN LM MARINE SEAL

Suits all Dunbier trailers with 39mm rod & 40mm square axles.
Large Cup LM67010 & Cone LM67048
Small Cup LM11910 & Cone LM11949, Seal # 1715
Display packed

1688S



BEARING SET - FORD SL STANDARD SEAL

Suits Dunbier Trailers with 45 & 50mm sq axles (slimline)
Large Cup L68110 & Cone L68149
Small Cup LM12710 & Cone LM12749, Seal #1706.
Display packed

1707S



BEARING SET - FORD SL MARINE SEAL

Suits Dunbier Trailers with 45 & 50mm sq axles (slimline)
Large Cup L68110 & Cone L68149
Small Cup LM12710 & Cone LM12749, Seal #1716.
Display packed

1712



DISC BRAKE PADS - MECHANICAL - STANDARD BACKING PLATE

Specialised pad material, specifically suits for mechanical trailer brakes.
Suits AL-KO® and Meher 2 bolt calipers, display packaged (4 per pack)

1933



DISC BRAKE PADS - MECHANICAL- STANDARD BACKING PLATE

Specialised pad material specifically suited for mechanical trailer brakes.
Suits most brands of caliper, display packaged (4 per pack)

1927



DISC BRAKE PADS - HYDRAULIC - STANDARD BACKING PLATE

Specialised pad material, specifically suited for hydraulic trailer brakes.
Suits AL-KO® and Meher calipers, display packaged (4 per pack)

1929



DISC BRAKE PADS - MECHANICAL - STAINLESS STEEL BACKING PLATE

SS backing plate resists corrosion. Ideal for salt water applications.
Suits most brands of caliper, display packaged (4 per pack)

1928



DISC BRAKE PADS - HYDRAULIC - STAINLESS STEEL BACKING PLATE

SS backing plate resists corrosion. Ideal for salt water applications.
Suits most brands of caliper, display packaged (4 per pack)

1930

BEST SELLERS - TIE-DOWNS

TIE-DOWNS



ALL DUNBIER TIE-DOWNS CONFORM TO THE AU & NZ SAFETY STANDARD AS/NZS4380:2001

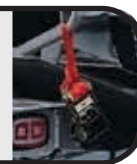

HEAVY DUTY TIE-DOWNS - TRANSOM PACK

270kg load rating, display packed, complete as shown, pair.

1.5m length x 50mm web width

3955



HEAVY-DUTY TIE-DOWN - OVER BOAT SYSTEM

270kg load rating, display packed, complete as shown, single.

5.5m length x 50mm web width

3957



MEDIUM-DUTY TIE-DOWNS - 2 PK

700kg breaking strength, display packed, complete as shown, pair.

280mm-1, 220mm adjustable length x 25mm web width

3974



LIGHT DUTY OVERCENTRE RATCHET TIE-DOWN

NZ made overcentre/gunwale tie-down for securing light boats to trailers. Breaking strength 450kg. Single pack.

4m length x 25mm width, PVC coated S-hooks

3930



ENDLESS HOOK TO HOOK RATCHET TIE-DOWN

For securing jet skis & small boats to trailers.

Breaking strength 800kg. Comes as a pair.

0.9m length x 25mm width, floating PVC coated S-hooks

3931



TRANSOM RATCHET TIE-DOWNS - STAINLESS STEEL

For securing boats to trailers at the transom/stern of the boat.

800kg breaking strength. Comes as a pair.

1.5m length x 25mm wide, PVC coated S-hooks

3937



TIE-DOWN MOUNT - TRAILER

Galvanised, adjustable, complete with bolt & nut

To suit 75mm x 50mm RHS

#3255

To suit 100mm x 50mm RHS

#3256

BEST SELLERS - ACCESSORIES

DRIVE-ON KITS

Upgrade your trailer performance and protect your hull. Simple, safe, and easy to install, Glider Kits & Self Centring systems dramatically improve your trailers "retrieving" by ensuring your boat is centred every time.

The oversize guides leave no room for error even in the toughest of conditions!

CONVERT YOUR WINCH TRAILER TO A DRIVE-ON OPTION!

- ✓ **HEAVY DUTY CONSTRUCTION**
- ✓ **EXCELLENT HULL SUPPORT**
- ✓ **CORROSION RESISTANT**
- ✓ **MOUNTING HARDWARE INCLUDED**

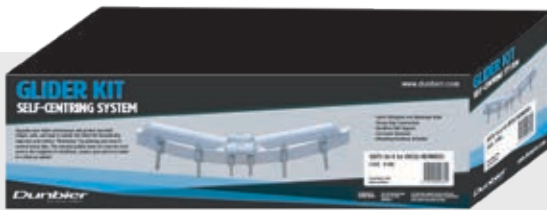

GLIDER KITS

Suitable for fibreglass and aluminium hulls.

Suits 50 x 50mm cross member

3108

Suits 75 x 50mm cross member

3109

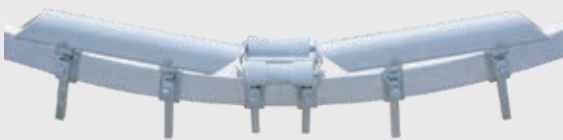

KIT INCLUDES



2 x #3250



4 x #3253 or #3252

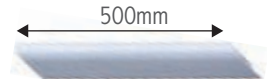

2 x #3105

Note: roller rail and keel rollers not included.

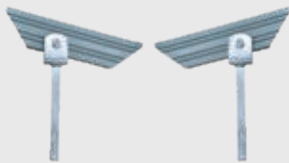

CENTRELINE KIT - SELF CENTRING SYSTEM

Suitable for aluminium hulls.

Suits #3252 slide frame mount

3093



LOCKABLE JERRY CAN HOLDER

Suits 75mm-100mm deep trailer side frames.

Heavy-duty galvanised steel construction, includes all mounting hardware & features anti-theft cable with lock.

Heavy-duty lockable jerry can holder

3920



WHEEL CLAMP - LOCKABLE

Heavy duty steel construction anti-theft device, with push to lock mechanism, suits most wheels 13"-15". Lock and key included.

Complete as shown

1534



COUPLING LOCK - TRAIL-SAFE

Designed to lock your trailer either on or off the vehicle, Includes a heavy duty pad lock.

Complete as shown

1522

CATEGORY INDEX

JOCKEY WHEELS & COUPLINGS

KNOTT Jockey Wheels.....	16
Jockey Wheel Replacement Parts & Hardware.....	16-17
Coupling Lock.....	16
Couplings.....	16-17

ELECTRICAL

L.E.D. Lamps.....	20
Lighting Replacement Parts.....	20-21
Trailer Plugs & Sockets.....	21-22
P-clips & Cable Ties.....	22

WINCHES

Replacement Winch Parts.....	19
Dunbier Winches.....	18
Fulton Winch.....	18
Winch Posts.....	19
Winch Carriers.....	19
Winch Post Caps.....	19

WHEELS & TYRES

Steel Rims & Tyres.....	23-24
Puma Alloy Rims & Tyres.....	24
PRIMAL Alloy Rims & Tyres.....	24
Spare Wheel Covers.....	25
Wheel Clamp.....	25
Wheel Chocks.....	25
Spare Wheel Carriers.....	25
Mudflaps.....	25
Mudguards.....	26
Mudguard Carriers.....	26
Wheel Nuts.....	26

AXLES, SUSPENSION & CHASSIS

Axles.....	36-36
Springs.....	37
Spring Kits.....	36
Spring Hangers & Parts.....	37
Walkways.....	38
Drawbar Keel Support.....	38
D.I.Y. Swing Drawbar.....	38
Parallel Members.....	39
Cross Members & Replacement Parts.....	39

BRAKES & HUBS

Bearing Protectors.....	27
Bearing Sets.....	27-28
Hub Seals.....	27-28
Wheel Hub Replacement Parts.....	28
Hub in a Tub Emergency Hub Replacement Kit.....	28
Wheel Bearing Grease.....	29
Wheel Hubs.....	29-30
Brake Calipers.....	30
Caliper Replacement Parts.....	31
Brake Pads.....	31
Brake Lines & Cables.....	32-33
Brake Line Replacement Parts.....	33
Brake Line Conversion Kits.....	32
Brake Controllers.....	34
Brake Controller Replacement Parts.....	34

HARDWARE

U-bolt Sets.....	40
Nuts, Bolts & Washers.....	40
Bow Rollers.....	41
V-blocks.....	41
Wobble Rollers.....	41
Keel Rollers.....	41-43
Parallel Rollers.....	41-43
Roller Replacement Parts.....	43
Roller Assemblies.....	43-45
Trailer Pad Strips.....	46
Bumper Blocks.....	46
Trailer Pads.....	46
U-brackets.....	47
Slide Brackets.....	47
Pad Brackets.....	47-48
D Shackles.....	48
R Clips.....	48
Safety Chain.....	48

TRAILER ACCESSORIES

Spare Wheel Covers.....	49
Wheel Clamp.....	49
Plastic Wheel Chocks.....	49
Coupling Lock.....	49
Beach Retrieving System.....	49
Self Centring System / Glider Kits.....	49
Plastic Trailer Pads.....	49
Tie-downs.....	50
Outboard Motor Supports.....	51
Guide Pole Set.....	51
Jerry Can Holder.....	51
Stickers.....	51

JOCKEY WHEELS & COUPLINGS



KNOTT JOCKEY WHEEL - SIDE WIND - SWING-UP

210mm x 50mm wheel, 545kg capacity, 255mm lift height

Fully galvanised and complete as shown

KNOTT

1293

210mm x 75mm wheel, 545kg capacity, 255mm lift height

Fully galvanised and complete as shown

1294



KNOTT JOCKEY WHEEL REPLACEMENT PARTS

KNOTT

Replacement KNOTT Gear Set Kit

1280

Replacement KNOTT Plastic Cap

1291

Replacement KNOTT handle to suit #1293

1295

Replacement KNOTT wheel to suit #1924

1296

Replacement KNOTT wheel to suit #1923

1298



#1353



#1355

FULTON JOCKEY WHEEL REPLACEMENT PARTS

FULTON

Replacement wheel to suit dual wheel

1354

Replacement wheel to suit single wheel

1354S

Replacement gear set & roll pins

1355

Replacement crank handle kit

1353

Replacement T-handle

1356



#1354S



#1354



#1356



MOUNTING BRACKET TO SUIT JOCKEY WHEEL

This galvanised bracket has been designed for larger drawbars where the standard mounting kit does not suit.

Suits 100-150mm deep drawbars and includes U-bolts

1286

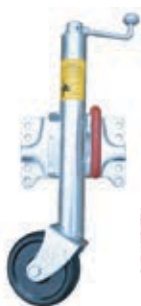

#1292



#1350



#1262

JOCKEY WHEEL - TOP WIND - SWING-UP

150mm x 50mm rubber wheel, 350kg lift capacity

Fully galvanised and complete as shown

1292

Replacement solid wheel 150 x 50mm

1350

Replacement crank handle

1361

200mm x 60mm steel & rubber wheel, 350kg lift capacity

Complete as shown

1262



#1361

JOCKEY WHEELS & COUPLINGS



JOCKEY WHEEL - STANDARD - TOP WIND

150mm x 50mm rubber wheel, 350kg lift capacity

Jockey wheel with clamp as shown # 1290
 Replacement solid wheel 150 x 50mm # 1350



250mm x 85mm steel & rubber wheel, 350kg lift capacity

Jockey wheel with clamp as shown # 1312
 Replacement solid wheel 150 x 50mm # 1352



REPLACEMENT RUBBER WHEEL

6" solid rubber wheel, 250kg weight capacity, complete with locking R-clip

Replacement solid rubber wheel # 1350
 Replacement R-clip # 1360



TRAIL-SAFE COUPLING LOCK

Designed to lock your trailer either on or off the vehicle, Includes a heavy-duty trail-safe lock.

Complete as shown, display packed # 1522



STANDARD TRAILER COUPLING - 50mm - 2000kg

Galvanised finish with 2000kgs towing capacity with optional ball head adjusting bolt. Meets Australian standards.

Complete as shown # 1010
 Replacement adjusting bolt # 1011
 Replacement trigger assembly kit # 1044C



HEAVY DUTY TRAILER COUPLING - 50mm - 3,500kg

Galvanised finish with 3500kgs towing capacity with Optional ball head adjusting bolt. Meets Australian standards.

Complete as shown # 1000
 Replacement adjusting bolt # 1011



HEAVY DUTY TRAILER COUPLING - 70mm - 4,500kg

Painted finish with 4500kgs towing capacity. Meets Australian standards.

Coupling only, less 70mm towball # 1014
 70mm towball only # 1045



MECHANICAL OVER-RIDE 50mm TRAILER COUPLING - 50mm - 2,000kg

Meets Australian standards. Note: towballs are not supplied with couplings

Galvanised finish with 2000kgs towing capacity # 1041
 Coupling 50mm towball to suit # 1061
 Replacement adjusting bolt # 1011
 Replacement reverse stop and bolt # 1042C

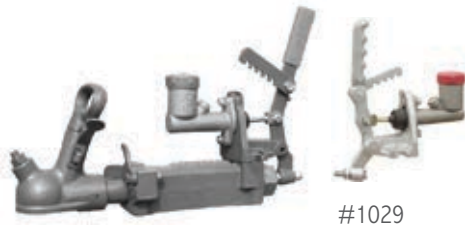

HYDRAULIC OVER-RIDE TRAILER COUPLING - 50mm - 2,000kg
Galvanised finish with 2000kgs towing capacity. Meets Australian standards.

- Coupling complete as shown, no towball # 1030
- Coupling 50mm towball to suit # 1061
- Replacement master cylinder and hand break assembly # 1029
- Replacement reverse stop and bolt # 1042C



MECHANICAL OVER-RIDE TRAILER COUPLING - 50mm - 2,500kg
3500kg coupling rating. Spring rated for use on trailers up to 2500kg ATM.
Note: towballs are not supplied with couplings. Meets Australian standards.

- Complete as shown #1032
- Coupling 50mm towball to suit # 1061
- Replacement adjusting bolt # 1011
- Replacement reverse stop and bolt # 1042C



TOW BALLS - CHROME
Meets Australian standards.

- Tow Ball 50mm # 1061
- Tow Ball 70mm # 1045



SNAP HOOK WINCH STRAP
7.5m length x 50mm width, snap hook
Complete as shown

1194



S-HOOK WINCH STRAP
6m length x 50mm width, S-hook
Complete as shown

1192



WINCH HANDLES

- AL-KO® handle, suits quick connect # 1210
- Dunbier handle, hex head # 1200

WINCHES

The Dunbier range of winches has been designed for salt water use and are easy to operate when launching and retrieving at the boat ramp.

Dunbier winches are used on all Dunbier trailer models.



3:1 WINCH & STRAP

6m strap, Stainless steel S-hook. 500kg capacity.
Dacromet coated for longer life.

Winch & strap as shown

1160G

Replacement winch pawl kit

7198



5:1 WINCH & STRAP

7m strap, heavy-duty snap hook. 500kg capacity.
Dacromet coated for longer life.

Winch & strap as shown

1161G

Replacement winch pawl kit

7198



TWO SPEED 5:1/1:1 RATIO WINCH & STRAP

7m strap, heavy-duty snap hook. 700kg capacity.
Dacromet coated for longer life. Includes handle.

Winch & strap as shown

1162G

Replacement winch pawl kit

7198

Replacement winch handle

1200



THREE SPEED 10:1/5:1/1:1 RATIO WINCH & STRAP

7m strap, heavy-duty snap hook. 800-1,000kg capacity.
Dacromet coated for longer life. Includes handle.

Winch & strap as shown

1163G

Replacement winch pawl kit

7197

Replacement winch handle

1200



THREE SPEED 15:1/5:1/1:1 RATIO WINCH & STRAP

7m strap, heavy-duty snap hook. 1,200kg capacity.
Galvanised finish. Includes handle.

Winch & strap as shown

1176



FULTON XLT WINCH

680kg capacity

2 way ratchet with neutral position

FULTON

1161



WINCH POST - GALVANISED

630mm x 50mm x 50mm square tube.

Suits Dunbier trailers 4.4 to 5.0m, base plate suits 76mm wide drawbar # 3448

690mm x 64mm x 64mm square tube.

Suits Dunbier trailers 4.4 to 5.0m, base plate suits 76mm wide drawbar # 3450

Suits Dunbier trailers 5.3 to 6.2m, base plate suits 100mm wide drawbar # 3449

700mm x 100mm x 100mm square tube.

Suits Dunbier trailers from 6.6m, base plate suits 100mm wide drawbar # 3451



WINCH POST - GALVANISED - HEAVY DUTY

700mm x 100mm x 100mm square tube.

Suits Dunbier trailers from 6.6m, base plate suits 100mm wide drawbar # 3451HD



WINCH CARRIER - PREMIUM - SUITS DUNBIER LOADER SERIES

Includes bow roller and end caps.

Suits 100mm x 100mm square winch post # 3460



WINCH CARRIER - PREMIUM - SUITS DUNBIER ALLOY SERIES TRAILERS

Includes premium bow roller and end caps.

Suits 100mm x 100mm square winch post # 3463



WINCH CARRIER - STANDARD - GALVANISED

Suits 50mm square tube and Dunbier trailers 3.7m to 4.3m # 3480

Suits 64mm square tube and Dunbier trailers 4.4m to 6.2m # 3490

Suits 100mm square tube and Dunbier trailers 6.6m to 8.0m # 3492



WINCH CARRIER - ELECTRIC - GALVANISED

Longer winch carrier to suit electric winches.

Suits 100mm square winch post # 3499

Suits 64mm square winch post # 3500



WINCH CARRIER - WATER TOY - DOUBLE

Galvanised and suits 50mm square winch post

3464



WINCH CARRIER & POST - WATER TOY

Small poly bow roller suits 100mm square winch post,

#9165P/#9169P Jet Ski trailers

3466



WINCH POST CAPS - PLASTIC

50mm square flat top (import) # 3456

50mm square slant top # 3452

Suits 64mm square slant top # 3453

100mm square # 3454

ELECTRICAL

The new 2023 series of L.E.D. lights are fully submersible, 12 volt powered, have a modern design and are backed by nationwide support. They're available as right/left lamp only, or in a kit including side markers and cables.

All Dunbier L.E.D. lights have been tested to Australian standards and are Australian Design Rules approved.

NEW!

ADR APPROVED ✓



DUNBIER L.E.D. LIGHT KIT 8m - DISPLAY PACKED

Standard for most trailers - NEW model for 2023!

Left & right hand lamps, fully loomed, quick install. Includes side markers.

Suits trailers up to 8m

NEW!

2459S



DUNBIER L.E.D. LEFT & RIGHT LIGHTS

Right & left hand lamps - NEW model for 2023!

Right & left hand lamps, inc. license plate lamp
(Display Packed)

2460S

Left hand lamp only, inc. indicator, stop/tail
(Sold individually, bulk pack)

#2453

Right hand lamp only, inc. indicator, stop/tail & license plate lamp
(Sold individually, bulk pack)

#2455

NEW!



DUNBIER L.E.D. LIGHT KIT 7.0m & 10m - TRAILER READY BULK

Standard for most trailers. Left & right hand lamps, fully loomed, quick install. Includes side markers.

Suits trailers up to 6m

2452

Suits trailers up to 8m

2451



DUNBIER L.E.D. LEFT & RIGHT HAND LIGHTS

Previous model right & left hand lamps

Left hand lamp, inc. indicator, stop/tail
(Sold individually, bulk pack)

#2481

Right hand lamp, inc. indicator, stop/tail & license plate lamp
(Sold individually, bulk pack)

#2482



DUNBIER L.E.D. SIDE MARKER LIGHT

Amber/Red colour, includes snap in base & wire tail with plug.

Complete as shown

#2479



REFLECTORS - SELF ADHESIVE

Available in white, red, or amber colour, these self adhesive reflectors are display packed and sold in pairs.

White: L70 x W 28mm	# 2451S
Amber: L70 x W 28mm	# 2452S
Red: L70 x W 21mm	# 2453S



LIGHT COVER - METAL

Metal trailer light cover, standard on Dunbier trailers.

Punched holes to suit large combination of lamps # 2496



LICENSE PLATE BRACKET - RUBBER - UNIVERSAL

Rubber, universal.

Suits most trailer tail lamps # 2497



7 PIN VEHICLE SOCKET - FLAT - PLASTIC

Suits vehicle male plug #2851

Flat, plastic finish # 2852



7 PIN PLUG - FLAT - PLASTIC

Features colour coded wiring screws and clear panel.

Suits female socket #2852.

Used in NSW and most other states # 2851



7 PIN PLUG - ROUND - ALLOY

Features colour coded wiring & screws. Suits female socket #2835.

Used in VIC and SA # 2834



7 PIN PLUG - ROUND - PLASTIC

Features colour coded wiring screws and clear panel. Suits female socket #2820 & #2835.

Used in NSW and most other states # 2830



7 PIN VEHICLE SOCKET - ROUND - PLASTIC

Suits trailer plug #2830.

Round, plastic finish # 2820



7 PIN VEHICLE SOCKET - ROUND - ALLOY

Suits trailer plug #2830

Round, metal finish # 2835



12 PIN PLUG - FLAT - ALLOY

Features colour coded wiring screws. Suits female socket #2836.

Used in NSW and most other states # 2837



12 PIN VEHICLE BASE - ALLOY

Features colour coded wiring screws. Suits female socket #2837.

Used in NSW and most other states # 2836



7 PIN TRAILER PLUG - ROUND - PLASTIC - SMALL

Features colour coded wiring screws & plastic finish.

Used in QLD and WA

2855



TRAILER ADAPTOR PLUG - 7 PIN FLAT & 7 PIN ROUND

#2852 to large 7 pin round #2830.

Suits flat socket on vehicle to round on trailer

2770



TRAILER ADAPTOR PLUG - 7 PIN FLAT TO 7 PIN SMALL

#2852 to small round #2855.

Suits vehicle female flat socket

2810



P-CLIPS

Ideal for chassis mounting brake lines.

3/16th Nylon cable clamps, sold per 100

2871



BLACK CABLE TIES

Plastic, sold per 100.

100mm (4") length

2730

200mm (8") length

2740

300mm (12") length

2750

370mm (14.5") length

2751





STEEL RIM & TYRE - 400 x 800

To suit Folding Trailers from February 2010.

Note: Special 140mm die & hub to suit this rim #1649

Rim and Tyre. Load capacity 268kgs.

1449



TYRE & TUBE - 500 x 10

Note: Rim not included.

500 x 10 Tyre & Tube

1400



13" STEEL RIM & TYRE - GALVANISED - 165/70R

To suit Ford, PCD 114mm. Note: Tyre is not sold separately.

Steel Rim and Tyre. 600kgs capacity.

Steel Rim Only (No Tyre)

1469

1492



13" STEEL RIM & TYRE - GALVANISED - 175R13LT

To suit Ford, PCD 114mm.

Galvanised Steel Rim and Tyre. 690kgs capacity.

Steel Rim Only (No Tyre)

175R 13LT Radial Tyre.

1467

1492

1466



13" STEEL RIM & TYRE - GALVANISED - MULTI FIT

Multi-fit rim to suit Ford or HT Holden, PCD 108mm & 114mm.

Steel Multi-Rim & ST175/80R x 13 Tyre. 615kgs capacity.

Steel Multi-Fit Rim Only (No Tyre). 690kgs capacity.

1464

1491

WHEELS & TYRES



14" STEEL RIM & TYRE - GALVANISED - 185R14C

To suit Ford, PCD 114mm.

Steel Rim & Tyre. 840kgs capacity	# 1472
Steel Rim Only (No Tyre). 850kgs capacity.	# 1493
185R14C Radial Tyre Only	# 1468



14" STEEL RIM & TYRE - GALVANISED - 195R14C

To suit Ford, PCD 114mm.

Steel Rim & Tyre. 950kgs capacity	# 1482
Steel Rim Only (No Tyre). 850kgs capacity	# 1493
195R14C Radial Tyre	# 1470



15" STEEL RIM & TYRE - 6 STUD - GALVANISED

To suit Landcruiser, PCD 140mm.

Steel Rim & P225/70 x 15 Tyre, 1100kgs capacity	# 1509
Steel Rim Only (No Tyre), 1180Kgs capacity	# 1512



PUMA ALLOY RIM & TYRE

To suit Ford.

13" Silver Rim Only (No Tyre)	# 1393
13" Black Rim Only (No Tyre)	# 1395
13" Silver Rim & Tyre 165RLT13	600kgs capacity # 1438
13" Black Rim & Tyre 165RLT13	600kgs capacity # 1439
13" Silver Rim & Tyre 175RLT13	690kgs capacity # 1430
13" Black Rim & Tyre 175RLT13	690kgs capacity # 1435



14" Silver Rim Only (No Tyre)	# 1394
14" Black Rim Only (No Tyre)	# 1396
14" Silver Rim & Tyre 185R14C	850kgs capacity # 1431
14" Black Rim & Tyre 185RLT14	850kgs capacity # 1436
14" Silver Rim & Tyre 195R14C	950kgs capacity # 1432
14" Black Rim & Tyre 195RLT14	950kgs capacity # 1437

15" Silver Rim Only (No Tyre)	# 1397
15" Silver Rim & Tyre 225/70R15C	1,100kgs capacity # 1433



PRIMAL ALLOY RIM & TYRE

To suit Ford or Landcruiser.

14" Rim Only suit Ford (No Tyre)	# 1498
14" Rim & Tyre suit Ford 185R14C	850kgs capacity # 1480
14" Rim & Tyre suit Ford 195R14C	850kgs capacity # 1484
14' Rim & Tyre suit L/C	950Kgs capacity # 1507
15" Rim suit Ford (No Tyre)	# 1499
15" Rim & Tyre suit Ford 205/70R/15C	900kgs capacity # 1487
15" Rim Only to suit L/C (No Tyre)	# 1500
15' Rim & Tyre to suit L/C 225/70R/15C	1100Kgs capacity # 1488





SPARE WHEEL COVERS

Back vinyl and white writing.

To suit 13" wheel

1520

To suit 14" wheel

1521



WHEEL CLAMP - LOCKABLE

Heavy duty steel construction anti-theft device, with push to lock mechanism, suits most wheels 13"-15". Lock and key included.

Complete as shown

1534

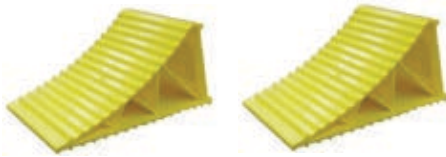

PLASTIC WHEEL CHOCKS

Easy to use and light for convenient storage. Sold in pairs.

Complete as shown

1524



BEACH LAUNCHER DROP DOWN SPARE WHEEL CARRIER

Galvanised for corrosion protection, heavy duty spring bolt, complete spare hub and high quality bearings. Comes display packed.

Complete with Ford LM Bearings

1516

Complete with Ford Slim Line Bearings

1517

Complete with HT LM Bearings

1518

Complete with HT Slim Line Bearings

1519



SPARE WHEEL CARRIER - STANDARD

Suits Ford & Holden stud patterns / 13" or 14" wheels. Galvanised for corrosion protection & features flexible 3 position mounting: drawbar, winch post and side frame.

Complete as shown, comes display packed

1532



SPARE WHEEL CARRIER - HEAVY DUTY

Suits Ford, Holden & L/C stud patterns, 13"/14"/15 wheels. Galvanised for corrosion protection & features flexible 3 position mounting: drawbar, winch post and side frame.

Measures 260mm high x 225mm wide.

Complete as shown, comes display packed

1531



SPARE WHEEL CARRIER - U-BOLT

Suitable for 13" & 14" wheels, flexible mounting options including drawbar, A-frame, winch post, rear bumper. Max. wheel weight 32kg.

Complete as shown, comes display packed

1525



MUDFLAP

Suits all sizes, black & white finish

#2225

WHEELS & TYRES



Nut & bolt set to suit plastic carrier.
Display packed (5 per pack) # 2409

MUDGUARDS - PLASTIC

WHEEL	COLOUR	CARRIER TO SUIT	PART #
13"	White (Wasson)	#2350R & #2350L	# 2380
13"	Grey (Wasson)	#2350R & #2350L	# 2380G
13"	Black (Wasson)	#2350R & #2350L	# 2380B
14"	White (Wasson)	#2360R & #2360L	# 2390
14"	Grey (Wasson)	#2360R & #2360L	# 2390G
14"	Black (Wasson)	#2360R & # 2360L	# 2390B



MUDGUARDS - ALLOY PLATE

Suits 13" & 14" tandem L1605mm x H380mm x W230mm

2260



MUDGUARDS - JEEP STYLE - RAW METAL FINISH

To suit size 9", 13" & 14"
To suit size 15" & 16"

2240
2238



GUARD CARRIER - SINGLE - TO SUIT PLASTIC MUDGUARDS

WHEEL SIZE	LOAD PER SPRING	PART #
13"	Single axle mudguard carrier R.H.	# 2350R
13"	Single axle mudguard carrier L.H.	# 2350L
14"	Single axle mudguard carrier R.H.	# 2360R
14"	Single axle mudguard carrier L.H.	# 2360L



GUARD CARRIER - TANDEM - TO SUIT PLASTIC MUDGUARDS

WHEEL SIZE	LOAD PER SPRING	PART #
13"	Tandem slipper spring mudguard carrier R.H.	# 2361
13"	Tandem slipper spring mudguard carrier L.H.	# 2362
14"	Tandem slipper spring mudguard carrier R.H.	# 2363
14"	Tandem slipper spring mudguard carrier L.H.	# 2364



GUARD CARRIER - TANDEM - TO SUIT ALLOY MUDGUARDS

WHEEL SIZE	LOAD PER SPRING	PART #
13"	Tandem slipper spring guard carrier, Steel Steps RH	# 2355
13"	Tandem slipper spring guard carrier, Steel Steps LH	# 2356
14"	Tandem slipper spring guard carrier, Steel Steps RH	# 2357
14"	Tandem slipper spring guard carrier, Steel Steps LH	# 2358



WHEEL NUTS 7/16" - STANDARD

Single wheel nut
Display packed (5 per pack)

1670
1660C



WHEEL NUTS 1/2" - STANDARD

Single wheel nut
Display packed (5 per pack)

1669
1661C



WHEEL NUTS 1/2" - DACROMET COATED TO SUIT ALLOY

Display packed (5 per pack)

1489



#1781

BEARING PROTECTORS - BEARING BUDDY®

Bearing Buddy

Chrome plated, with stainless steel components.

Made in USA, packaged and sold in pairs.

To suit 50mm x 63mm 2 tonne axles

Bearing Buddy suits LM and SL hubs

1781

1780



#1780



BEARING PROTECTORS - DUNBIER - TO SUIT BRAKED & NON-BRAKED HUB

Suits braked and non-braked hubs with a 45mm internal snout dimension. PVC dust covers included.

Display packed, sold in pairs

1779



BEARING PROTECTORS - TO SUIT TROJAN®

Suits TROJAN® 65mm square 2 tonne axles. Includes dust covers and sold in pairs.

Complete as shown

1778



BEARING PROTECTOR COVERS - PVC

Suit most bearing protectors.

Display packed, 2 per pack

1782

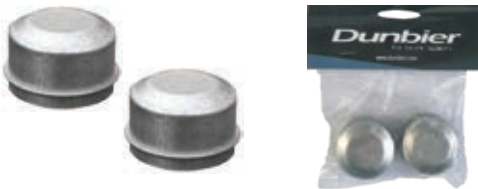

GREASE CAPS - GALVANISED STEEL

Standard. Suits 45mm snout.

Sold in pairs

Sold in a pair, display packed

1740

1740P



1706

1710

#1705

WHEEL HUB SEALS - ONE PART

Suits: 39mm round to 40mm square axles

Suits: 45mm sq axles slimline

Suits Holroyd 50mm axles (Seal dia. OS 86 x IS 47.5)

1710

1706

1705



WHEEL HUB SEALS - TWO PART

Single: Suits Trailers with 39 & 40mm axles

Display packed (2 per pack)

1715B

1715S

Single: Suits trailers with 45mm axles

Display packed (2 per pack)

1716

1716S

Single: Suits Holroyd & Meher 50 & 65mm, 2.2 tonne axles.

Single: Suits AL-KO® 65mm, 2.2 tonne axles

Single: Suits TROJAN® 65mm 2.2 tonne axles

1717

1718

1719

BRAKES & HUBS



BEARING SET - HOLDEN LM STANDARD SEAL

Suits all Dunbier trailers with 39mm rod & 40mm square axles.

Large Cup LM67010 & Cone LM67048

Small Cup LM11910 & Cone LM11949, Seal # 1710

Display packed

1690S



BEARING SET - HOLDEN LM MARINE SEAL

Suits all Dunbier trailers with 39mm rod & 40mm square axles.

Large Cup LM67010 & Cone LM67048

Small Cup LM11910 & Cone LM11949, Seal # 1715

Display packed

1688S



BEARING SET - FORD SL STANDARD SEAL

Suits Dunbier Trailers with 45 & 50mm sq axles (slimline)

Large Cup L68110 & Cone L68149

Small Cup LM12710 & Cone LM12749, Seal #1706.

Display packed

1707S



BEARING SET - FORD SL MARINE SEAL

Suits Dunbier Trailers with 45 & 50mm sq axles (slimline)

Large Cup L68110 & Cone L68149

Small Cup LM12710 & Cone LM12749, Seal #1716.

Display packed

1712



BEARING SET - STANDARD SEAL - 2.2T HOLROYD

Suits Dunbier Trailers with Holroyd 65mm sq tube axle.

Large Cup 25520 & Cone 25580

Small Cup LM67010 & Cone LM67048

Seal to suit: # 33940, sold as complete kit

1708



BEARING SET - MARINE SEAL - 2.2T - AL-KO®

Suits Dunbier Trailers with AL-KO® 65mm tube square axles.

Large Cup & Cone # HR30210

Small Cup # 15123 & Cone # 15245

Two Part Seal # 82140, sold as complete kit

1708A



BEARING SET - MARINE SEAL - 2.2T - AL-KO®

Suits Dunbier Trailers with Trojan 65mm tube square axles.

Cup # LM44649 & LM48548

Cone # LM4464610 & LM 48510

Two Part Seal # PT10141, Sold as complete kit.

1711S



WHEEL STUDS - ZINC PLATED

7/16" - Single hub stud only, no nut

7/16" - 5 x hub studs only, no nut. Display Packed.

1/2" - Single hub stud only, no nut

1/2" - 5 x hub studs only, no nut. Display Packed.

1673

1673C

1674

1674C



WHEEL STUD & NUT KIT - ZINC PLATED

7/16" - 5 x hub studs & nuts. Display Packed.

1/2" - 5 x hub studs & nuts. Display Packed.

1663C

1664C



AXLE SPLIT PINS - M4 x 25mm - ZINC PLATED

Single split pin

Display packed (10 per pack)

1681

1680



AXLE NUT, WASHER & SPLIT PIN KIT - SUIT AXLES 39MM ROUND TO 45MM SQ

Zinc plated

Display packed (2 x nut, 2 x washer, 2 x split pin)

1622C



WHEEL BEARING GREASE - FUCHS

FUCHS high temperature wheel bearing grease in a tub or cartridge.
Suitable for all type of trailers operating in extreme conditions.

500gm tub

1831

450gm cartridge

1832



HUB IN A TUB - COMPLETE HUB REPLACEMENT KIT

One of our most popular items, Hub In A Tub Includes everything you need to change a hub in an emergency - packed with grease, wheel hub, bearings, seals, grease caps and wheel nuts.

Suits Ford with LM series bearings

1665

Suits Ford with Slimline series bearings

1666

Suits HT Holden with LM series bearings

1667

Suits HT Holden with Slimline series bearings

1668

“ I NEVER LEAVE HOME WITHOUT ONE... ”
 - DUNBIER AMBASSADOR
 ANDREW 'ET' ETTINGSHAUSEN

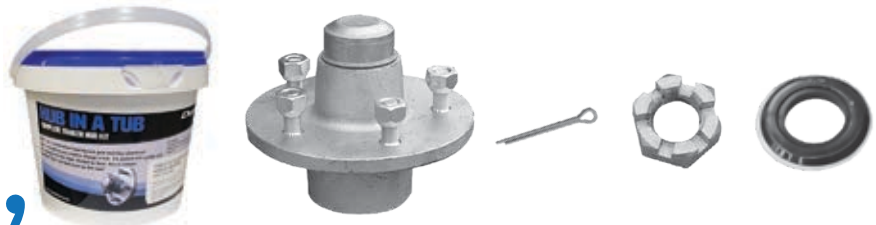

WHEEL HUB - FOLDING TRAILER - 140mm - FORD STUD BEARINGS

Galvanised, 1/2" x 5 stud pattern, Pitch Circle Dia. 114mm

Includes Ford LM bearings, seal and grease cap.

Suits Folding Trailer from March 2010

1652



WHEEL HUB - 150mm - HOLDEN LM BEARINGS

Galvanised, 7/16" x 5 stud pattern, Pitch Circle Dia. 108mm

Includes LM bearings, seal and grease cap.

Suits Dunbier and most other brands of trailers.

1653

WHEEL HUB - 150mm - HD FORD LM BEARINGS

Galvanised, 1/2" x 5 stud pattern, Pitch Circle Dia. 114mm

Includes heavy duty LM bearings, seal and grease cap.

Suits Dunbier and most other brands of trailers.

1649

WHEEL HUB - 150mm - HD FORD SL BEARINGS

Galvanised, 1/2" x 5 stud Ford pattern, Pitch Circle Dia. 114mm

Includes heavy duty SL bearings, seal and grease cap.

Suits Dunbier and most other brands of trailers.

1649F



DISC BRAKE WHEEL HUB - GALVANISED - 5 STUD

Galvanised, 5 stud pattern, no seal.

Suits 13" & 14" wheels, hydraulic or mechanical calipers.

5 stud Ford pattern with Holden LM bearing set

1912

5 stud Ford pattern with Ford SL bearing set

1912SL

5 stud HT pattern with Holden LM bearing set

1908G

5 stud HT pattern with Ford SL bearing set

1908SL



DISC BRAKE WHEEL HUB - GALVANISED - 6 STUD

16mm disc with Landcruiser stud pattern. Includes bearings, two part seal and dust cap. Suits AL-KO® 65mm square tube axle.

6 stud Landcruiser pattern with bearing set

1909



DISC BRAKE WHEEL HUB - STAINLESS ROTOR - 6 STUD - 2.2T

Galvanised hub, 275mm x 11mm stainless rotor. Includes bearings, two part seal, dust cap.

6 stud Landcruiser pattern with bearing set

1918



DISC BRAKE WHEEL HUB - STAINLESS ROTOR - 5 STUD - 1.5T

Galvanised hub, 225mm x 11mm stainless rotor. Includes SL bearings, two part seal, dust cap.

5 stud Dunbier pattern with bearing set

1919



DISC BRAKE WHEEL HUB - CAST IRON ROTOR - 6 STUD - 2.2T

Galvanised hub, 275mm x 11mm cast iron rotor. Includes bearings, two part seal, dust cap.

6 stud Landcruiser pattern with bearing set

1920



REPLACEMENT DISC BRAKES - ROTORS ONLY

275mm x 11mm, 2.2 tonne.

Stainless

1921

Cast iron

1922



HYDRAULIC BRAKE CALIPER - STAINLESS - TROJAN®

Includes brake pads and mounting bolts.

Stainless Steel Caliper: Suits 11mm width rotor

1923

Stainless Steel Caliper: Suits 15mm width rotor

1924

Caliper axle mount to suit: 11mm rotor

1958

Caliper axle mount to suit: 15mm rotor

1970



HYDRAULIC BRAKE CALIPER - CAST IRON - TROJAN®

Includes brake pads and mounting bolts.

Cast Iron Caliper: Suits 11mm width rotor

1926

Cast Iron Caliper: Suits 15mm width rotor

1925

Caliper axle mount to suit: 11mm rotor

1958

Caliper axle mount to suit: 15mm rotor

1970



HYDRAULIC DISC BRAKE CALIPER - AL-KO®

Sold in pairs, includes brake pads and mounting bolts.

Suits Dunbier hydraulic brake axles, AL-KO® and Meher

1956



MECHANICAL DISC BRAKE CALIPER

Complete as shown, includes pads.

Suits all Dunbier mechanical brake axles

1971



DISC BRAKE PADS - MECHANICAL - STANDARD BACKING PLATE

Specialised pad material, specifically suits for mechanical trailer brakes.
Suits AL-KO® and Meher 2 bolt calipers, display packaged (4 per pack) # 1933



DISC BRAKE PADS - MECHANICAL- STANDARD BACKING PLATE

Specialised pad material specifically suited for mechanical trailer brakes.
Suits most brands of caliper, display packaged (4 per pack) # 1927



DISC BRAKE PADS - HYDRAULIC - STANDARD BACKING PLATE

Specialised pad material, specifically suited for hydraulic trailer brakes.
Suits AL-KO® and Meher calipers, display packaged (4 per pack) # 1929



DISC BRAKE PADS - MECHANICAL - STAINLESS STEEL BACKING PLATE

SS backing plate resists corrosion. Ideal for salt water applications.
Suits most brands of caliper, display packaged (4 per pack) # 1928



DISC BRAKE PADS - HYDRAULIC - STAINLESS STEEL BACKING PLATE

SS backing plate resists corrosion. Ideal for salt water applications.
Suits most brands of caliper, display packaged (4 per pack) # 1930

NEW!



CALIPER PISTON - HYDRAULIC - STAINLESS STEEL

Replacement parts.

Suits AL-KO® and Meher hydraulic calipers (#1956) # 1953



O-RING & BOOT SET - HYDRAULIC CALIPER

Complete as shown.

Suits AL-KO® and Meher hydraulic calipers (#1956) # 1954



SLIDE PIN KIT - HYDRAULIC

Complete as shown.

Suits AL-KO® and Meher hydraulic calipers (#1956) # 1955



1958

1970

DISC BRAKE CALIPER MOUNTS - MECHANICAL & HYDRAULIC

Complete as shown.

Suits Dunbier hydraulic axles

1958

Suits Dunbier mechanical axles

1970



BRAKE CALIPER SLIDER - MECHANICAL

Stainless steel, sold in pairs.

Suits all mechanical calipers

1969P

BRAKES & HUBS



BRAKE LINES - FLEXIBLE BRAIDED STAINLESS STEEL

Stainless steel flexible braided brake lines with brass end fittings. No flaring required and outlasts conventional steel brake tubing. Matches original brake line fittings on most trailers.

500mm length.....	# 1893
650mm length.....	# 1894
750mm length.....	# 1895
1000mm length.....	# 1896
1750mm length.....	# 1897
2000mm length.....	# 1898
6000mm length.....	# 1899
6500mm length.....	# 1901



FLEXIBLE BRAKE HOSE - HYDRAULIC

Suits all hydraulic 3/16" brass brake fittings

1850



BRAKE LINES - STEEL - BRASS FITTINGS

460mm length, suits 3/16" fittings	# 1890
560mm length, suits 3/16" fittings	# 1891
1420mm length, suits 3/16" fittings	# 1892
1780mm length, suits 3/16" fittings	# 1900

BRAKE LINE KIT - 4 WHEEL - #1886

Components include:

1 x #1901, 3 x #1896, 2 x #1897, 1 x #1893, 3 x #1860

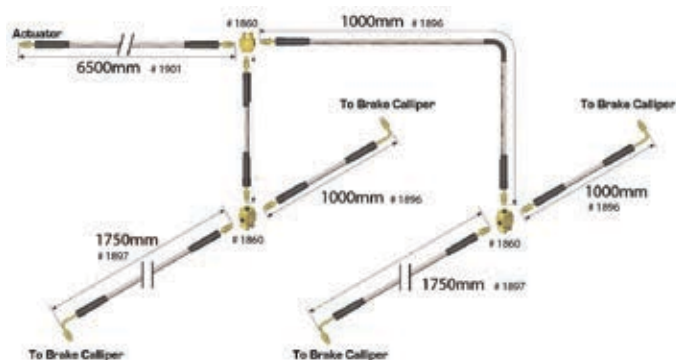

BRAKE LINE KIT - 2 WHEEL - #1887

Complete Kit #1886 includes:

1 x #1901
1 x #1896
1 x #1897
1 x #1860

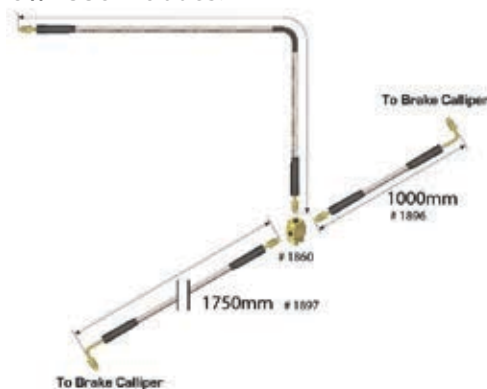

MECHANICAL BRAKE CONVERSION KIT

This mechanical brake conversion kit includes everything you need to convert your trailer to an over-ride mechanical brake system. Included is:

- 1 x 10M of Brake Cable
- 1 x Hand Brake Assembly
- 2 x Mechanical Disc Calipers
- 1 x Mechanical Override Coupling
- 2 x Caliper Mounts, including bolts
- 2 x Galvanised Disc Hubs, LM Bearings and dust caps

Brake Kit with Ford Discs

1845G

Brake Kit with HT Holden Discs

1846G



STUB AXLES - RAW METAL FINISH

39mm x 200mm, suits LM Bearing set

1630

45mm x 200mm, suits Slimline Bearing sets

1631



AXLE SADDLE - GALVANISED

Suits: 39mm Round Axle

1621



AXLE SADDLE - SQUARE - BLACK METAL

Black metal (single)

1620

Galvanised (single)

1620G

Galvanised (2 per pack)

1620GC



BRAKE LINE JOINER

Union for joiner 3/16 lines

1870



BRAKE LINE 3 WAY TEE

3 way tee. Brass material, suits 3/16" brake lines

1860



BRAKE LINE CONNECTOR - HYDRAULIC

Suits hydraulic master cylinders and hydraulic calipers
Copper washer (sold separately)

1880

1881



BRAKE COUPLING MASTER CYLINDER - HYDRAULIC

Hydraulic master cylinder
Hydraulic master cylinder replacement plastic cap

1840

1841



DISC BRAKE CALIPER SPRING - MECHANICAL

Replacement stainless steel spring (pair)

1977



CALIPER SPRING AND BOLT - MECHANICAL

Replacement stainless steel spring, wishbone type

1979



BRAKE CABLE - MECHANICAL

Galvanised & PVC coated, sold by the metre

1974



BRAKE CABLE ADJUSTER AND PULLEY - MECHANICAL

Galvanised & complete as shown

1972



BRAKE CABLE CLAMP KIT

Complete as shown, single only
Display Packaged (2 Per Pack)

1973

1976



BRAKE CABLE KIT - MECHANICAL

Cable adjuster, 8m PVC coated cable and two clamps. Display packaged.
Galvanised & complete as shown

1845



MECHANICAL BRAKE HANDBRAKE ASSEMBLY

Suits 76mm square tube, complete as shown

1090

Suits 100mm square tube, complete as shown

1093

Suits 130mm square tube, complete as shown

1094

Suits 100mm x 150mm drawbar, complete as shown

1096

BRAKES & HUBS



BRAKE ACTUATOR - AL-KO® IQ7

Only AL-KO IQ7 stores compressed air within a pressure chamber, allowing immediate brake application the instant it's required. Designed to significantly improve stopping performance and safety on trailers with hydraulic brakes, especially large boat trailers.



AL-KO® IQ7 brake actuator
Mounting bracket for AL-KO® IQ7
Bleed Gun assembly MK5, suits IQ7 and Sensabrake

1946
1940IQ
1947



#7202A



#7202B

COIL SOLENOID ASSEMBLY - HYDRASTAR

Hydrastar Solenoid Coil Assembly
Hydrastar Solenoid Valve

7202A
7202B



GASKET SET - HYDRASTAR

Replacement gasket set

7200



BREAKAWAY SWITCH

Replacement switch, as shown

#7205



DUNBIER IQ7 POWER CABLE

Power cable between vehicle and trailer - 7 pin
Power cable between vehicle and trailer - 12 pin

#1941
#2837SIG



PREDATOR DX2 BRAKE CONTROLLER

In vehicle electronic brake controller for single or tandem axle. Digital LED displays voltage output and assists with level set-up. Displayed pack, designed to work with Hydrastar braking

1945



PLASTIC CAP - HYDRASTAR

Replacement cap

7201



DETECTOR BOARD - HYDRASTAR

Replacement detector board

7207

AXLES, SUSPENSION & CHASSIS

SOLID ROUND AXLES - 39mm - GALVANISED

Suits seal #1710. Suits bearing sets LM67010 & LM11910 / LM67048 & LM11949. Suits Dunbier trailers only.



	WHEEL SIZE	O/A LENGTH	PART #
Axle bar only	13"	1800 (71")	# 1549G
Axle with Ford hubs & LM bearings	13"	1800 (71")	# 1550G
Axle bar only	13"	1675 (66")	# 1563G
Axle with Ford hubs & LM bearings	13"	1675 (66")	# 1562G

SOLID SQUARE AXLES - 40mm - GALVANISED

Suits seal #1710. Suits bearing sets LM67010 & LM11910 / LM67048 & LM11949. Suits Dunbier trailers only.



	WHEEL SIZE	O/A LENGTH	PART #
Axle bar only	13"/14"	1920 (75.5")	# 1571G
Axle with Ford hubs & LM bearings	13"/14"	1920 (75.5")	# 1570G

SOLID SQUARE AXLES - 40mm - GALVANISED

Suits bearing sets LM67010 & LM11910 / LM68148. For stud, Ford bearings. Suits Dunbier trailers only.



	WHEEL SIZE	O/A LENGTH	PART #
Axle to suit hyd. disc brake	13"/14"	1920 (75.5")	# 1602G
Axle to suit mech. disc brake	13"/14"	1920 (75.5")	# 1603G

SOLID SQUARE AXLES - 45mm - GALVANISED

Suits seal #1706. Suits bearing sets L68110 & LM12710 / L68149 & LM12749. Ford Stud, Ford bearings. Suits Dunbier trailers only.



	WHEEL SIZE	O/A LENGTH	PART #	
NON BRAKED	Axle bar only	13"/14"	1920 (75.5")	# 1577G
	Axle with Ford hubs & bearings	13"/14"	1920 (75.5")	# 1576G
	Axle bar only	13"/14"	2170 (85.5")	# 1583G
	Axle with Ford hubs & bearings	13"/14"	2170 (85.5")	# 1582G
	Axle bar only	13"/14"	2340 (92")	# 1589G
	Axle with Ford hubs & bearings	13"/14"	2340 (92")	# 1588G
DISC BRAKED	Ford mech. axle	13"/14"	1920 (75.5")	# 1607G
	Ford hyd. axle	13"/14"	1920 (75.5")	# 1606G
	Ford mech. axle	13"/14"	2170 (85.5")	# 1609G
	Ford hyd. axle	13"/14"	2170 (85.5")	# 1608G
	Ford mech. axle	13"/14"	2340 (92")	# 1592G
	Ford hyd. axle	13"/14"	2340 (92")	# 1591



OVERLAY SQUARE AXLES - 45mm - GALVANISED

Suits seal #1706. Suits bearing sets L68110 & LM12710 / L68149 & LM12749. Ford stud, Ford bearings. Suits Dunbier trailers only.



	WHEEL SIZE	O/A LENGTH	PART #	
NON BRAKED	Axle to suit bar only overlay	13"/14"	2190 (86")	# 1568G
	Axle with lazy hubs & bearings	13"/14"	2190 (86")	# 1569G
DISC BRAKED	Axle hyd. disc brake	13"/14"	2190 (86")	# 1611
	Axle mech. disc brake	13"/14"	2190 (86")	# 1610



SQUARE DISC AXLES -50mm - MECHANICAL & HYDRAULIC

Suits seal #1706. Suits bearing sets L68110 & LM12710 / L68149 & LM12749. Ford stud, Ford bearings. Suits Dunbier trailers only.



	WHEEL SIZE	O/A LENGTH	PART #
Mechanical - Ford disc axle	13"/14"	1920 (75.5")	# 1615
Hydraulic - Ford disc axle	13"/14"	1920 (75.5")	# 1614
Axle bar only	13"/14"	1920 (75.5")	# 1612G
Mechanical - Ford disc axle	13"/14"	2170 (85.5")	# 1617
Hydraulic - Ford disc axle	13"/14"	2170 (85.5")	# 1616

AXLES, SUSPENSION & CHASSIS



OVERLAY SQUARE AXLES - 50mm - GALVANISED

Seal: #1711. Bearing Set: 2200kgs LM44649/LM4464610 & LM48548/LM48510
 Seal: #1706. Bearing Set: 1750kgs L68110/LM12710 & L68149/LM12749
 Suits Dunbier trailers only.

	O/A AXLE LENGTH	PART #
Overlay mech. brake 50mm axle	2170 (85.5")	# 1592
Overlay hyd. brake 50mm axle	2170 (85.5")	# 1593
Overlay bar only 50mm axle	2170 (85.5")	# 1594
Overlay mech. brake 50mm axle	1920 (75.5")	# 1595
Overlay hyd. brake 50mm axle	1920 (75.5")	# 1596
Overlay bar only 50mm axle	1920 (75.5")	# 1597
Overlay mech. disc 50mm axle	2390 (94")	# 1598
Overlay hyd. disc 50mm axle	2390 (94")	# 1599
Overlay lazy 50mm axle	2390 (94")	# 1600



LOADER PRO SQUARE AXLE GULL WING - 50mm - GALVANISED

Seal: #1706. Bearing Set: L68110/LM12710 & L68149/LM12749. Chassis width 1725mm.
 Suits Dunbier trailers only.

	WHEEL SIZE	O/A AXLE LENGTH	PART #
Axle: bar only gull wing	13"/14"	2150 (84.6")	# 1623
Axle: lazy hubs & bearings	13"/14"	2150 (84.6")	# 1624
Mechanical: Ford disc axle	13"/14"	2150 (84.6")	# 1625
Hydraulic: Ford disc axle	13"/14"	2150 (84.6")	# 1626



SQUARE AXLE - 65mm - HYDRAULIC - 6 STUD DISC - 2.2 TONNE

Suits Dunbier trailers only. Chassis width - 1720mm

AL-KO® Bearing Set - HR30210/15123 & 15245, Seal: #182140

HOLROYD Bearing Set - 25520/25580 & LM67010/LM67048, Seal: # 821230

TOJAN® Bearing Set - LM44649/LM4464610 & LM48548/LM48510, Seal: #1711

	WHEEL SIZE	O/A AXLE LENGTH	PART #
TROJAN L/C hyd. disc axle	14"/15"	2200 (86.5")	# 1618T
TROJAN axle bar only	14"/15"	2200 (86.5")	# 1632



SPRING KIT FOR BOAT TRAILERS - DACROMET® COATED

Kit includes all components necessary for a complete spring replacement, including: 2 x Slipper Springs, 2 x Fish Plates, 2 x Spring Bolts, and 2 x U-bolts & nuts for mounting. Comes display packaged.

DESCRIPTION/SIZE	U-BOLT SET	LOAD PER KIT	PART #
3 Leaf x 45mm W x 780mm L	Round	800kg	# 2014K
4 Leaf x 45mm W x 780mm L	Square	1100kg	# 2019K
5 Leaf x 45mm W x 780mm L	Square	1200kg	# 2015K
6 Leaf x 45mm W x 780mm L	Square	1400kg	# 2016K
7 Leaf x 45mm W x 780mm L	Square	1500kg	# 2017K
9 Leaf x 45mm W x 780mm L	Square	1800kg	# 2018K

AXLES, SUSPENSION & CHASSIS

SLIPPER SPRINGS - DACROMET® COATED



DESCRIPTION/SIZE	LOAD PER SPRING	PART #
3 Leaf x 45mm W x 780mm L	400kg	# 2014
4 Leaf x 45mm W x 780mm L	550kg	# 2019
5 Leaf x 45mm W x 780mm L	600kg	# 2015
6 Leaf x 45mm W x 780mm L	700kg	# 2016
7 Leaf x 45mm W x 780mm L	750kg	# 2017
9 Leaf x 45mm W x 780mm L	900kg	# 2018
10 Leaf x 45mm W x 780mm L	1000kg	# 2021



LOAD SHARE SPRINGS - DACROMET® COATED

DESCRIPTION/SIZE	SUITS	LOAD PER SPRING	PART #
60mm with x 9 leaf, 4.4 tonne	15" wheel	4,400kg	# 2008
60mm width x 7 leaf, 3.5 tonne	13" / 14" wheel	3,500kg	# 2012

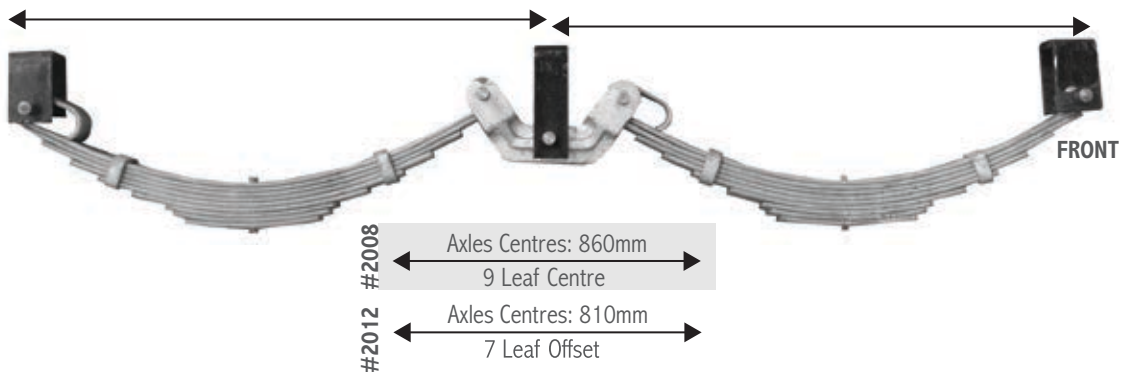

SLIPPER SPRING SHACKLE BOLT - GALVANISED

Suits 45mm slipper spring. Display packaged.

2070C



SLIPPER SPRING SHACKLE BUSH

Suits 45mm slipper spring. Display packaged & sold in pairs.

2060C



FISH PLATES - GALVANISED

Suits 45mm wide springs and 42mm wide U-bolt (bulk)

2020

Suits 60mm L/Share spring and 45 to 52mm wide ubolts (bulk)

2022

Suits 60mm wide L/Share spring and 65mm wide ubolt (bulk)

2023



STANDARD FRONT SPRING HANGER

Suits 45mm wide spring, raw metal finish

2030

Suits 45mm wide spring, galvanised finish

2030G



REAR SPRING HANGER

Suits 45mm wide spring. Raw metal finish

2050

Suits 45mm wide spring. Galvanised finish

2050G



STANDARD DEEP FRONT SPRING HANGER

Suits 45mm wide spring. Raw metal finish.

2040

Suits 45mm wide spring. Galvanised finish.

2040G

NEW!



RAIL MOUNT KIT - LOADER PRO

Galvanised complete with bolts & nuts

9732

AXLES, SUSPENSION & CHASSIS

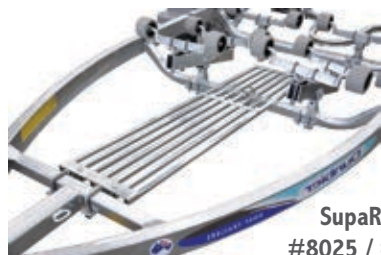

SupaRolla
#8025 / #8026



#8035 to #8050



#8031 to #8033



#8066 Walkway
Mount Kit

TRAILER WALKWAYS - GALVANISED

DESCRIPTION

PART

Straight walkway suits Dunbier SupaRolla Series (4.7m-5.0m) Includes: 1x # 8066 mount kit & 2 x 2130B front mounting ubolts	# 8025
Straight walkway suits Dunbier SupaRolla Series (5.3m-6.2m) Includes: 1x # 8066 mount kit & 2 x 2130B front mounting U-bolts	# 8026
Gal walkway: 5.3M front 1155MM Suits: Sports Centreline Series	# 8031
Gal walkway: 5.0M front 1205MM Suits: Sports Centreline Series	# 8032
Gal walkway: 4.7M front 1215MM Suits: Sports Centreline Series	# 8033
Straight walkway suits Dunbier Sports Series, 4.2M to 4.7M, Loader & Rollamatic Series 5M (# 1) Includes: 1x # 8066 mount kit & 1 x 2150B front mounting ubolt	# 8035
Straight walkway suits Dunbier Sports & Centreline Series (4.4m-4.7m & 5.3m) and Loader & Rollamatic Series (#2) Includes: 1x # 8066 mount kit & 1 x 2150B front mounting U-bolt	# 8040
Straight walkway suits Dunbier 5m Centreline, 5.7m & 6.2m Loader and Rollamatic Series (#3) Includes: 2 x # 8066 mount kit & 1 x 2160B front mounting U-bolt	# 8045
Straight walkway suits Dunbier 5.3m Centreline, 6.5m Loader and Rollamatic Series (#4) Includes: 2x # 8066 mount kit & 1 x 2160B front mounting U-bolt	# 8050
Walkway mounting kiit	# 8066



DRAWBAR KEEL SUPPORT - KAYAKS

Fits forward of the drawbar, 'V' suits most kayaks.

Suits 75mm square tube, complete with U-bolt and rubber 'V' block # 3133



3954

Example of finished
product fitted to trailer.



SWING DRAWBAR - D.I.Y.

Raw metal finish and engineered to suit trailers with a GVM to 3.0 tonne.

The kit requires welding on installation by a professional welder. Complete with drop pin as shown.

Suits 76mm square drawbar	# 3945
Suits 100mm square drawbar	# 3946
Replacement pin to suit	# 3954



CROSS MEMBER STOP - REAR SWING

Replacement U-bolt only, 67mm x 60mm x12mm	# 2121
Complete as shown, with U-bolt	# 3341



CROSS MEMBER PLATE WITH U-BOLTS - UNIVERSAL

Suits 50mm x 50mm tube	# 3119
Suits 75mm x 50mm tube	# 3120
Suits 100mm x 50mm tube	# 3121



SUPA-ROLLA CENTRE PARALLEL MEMBER - 50x50x600

Suits Supa-Rolla arm assembly x 2 sets #3261

Size 50mm x 50mm x 600mm

3293



3294

SUPA-ROLLA REAR PARALLEL MEMBERS - 75x50x700

Suits Supa-Rolla arm assembly x2 or x4 sets #3261

Size 75mm x 50mm x 700mm - suits 2 sets #3261

3294



3295

Size 75mm x 50mm x 700mm - suits 4 sets #3261

3295



SUPA-ROLLA REAR PARALLEL MEMBER - 50x50x600

Suits Supa-Rolla arm assembly x 4 sets #3261

Size 75mm x 50mm x 900mm

3297



REAR CROSS MEMBER - SUPA-ROLLA & ROLLAMATIC

Material size: 50mm square, complete with adjustable stop.

Suits Dunbier standard frame width 1465mm

3344



REAR SWING MEMBER - SUPA-ROLLA & ROLLAMATIC

Material size: 75MM x 50mm, complete with adjustable stop.

Suits Dunbier wide frame width 1725mm

3345



REAR SWING CROSS MEMBER - LOADER

Material size: 50mm square, suits trailers from October 2005.

Suits Dunbier frame width 1465mm

3343

Suits Dunbier wide frame width 1725mm

3343W



REPLACEMENT CROSS MEMBERS - SUPA-ROLLA - GALVANISED

W1365 x D50 x 50mm

3326

W1625 x D50 x 50mm

3328

W1625 x D75 x 50mm

3329



REPLACEMENT CROSS MEMBERS - 'V' SHAPE - GALVANISED

Shallow 'V', W1365 x D50 x 50mm

3325

Shallow 'V', W1625 x D50 x 50mm

3327

HARDWARE

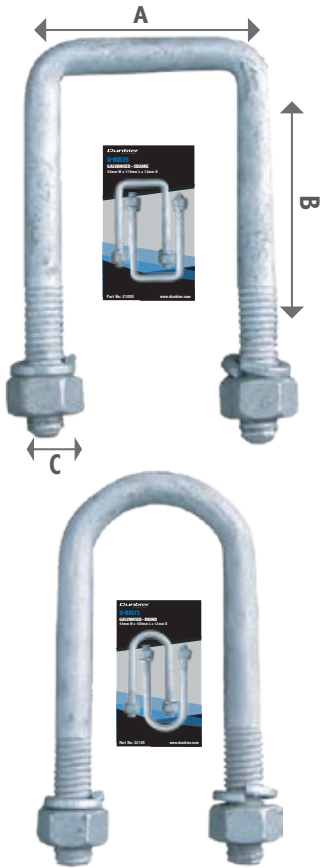

U-BOLT SETS - GALVANISED

A	B	C	SHAPE	BULK #	DISPLAY PACKED (PAIRS) #
22 x 95 x 10mm			Square	# 2196	
24 x 60 x 10mm			Square	# 2191B	# 2191S
41 x 45 x 10mm			Square	# 2197	
42 x 115 x 12mm			Square	# 2100B	# 2100S
44 x 100 x 12mm			Round	# 2210B	# 2210S
47 x 140 x 12mm			Square	# 2213	
52 x 80 x 12mm			Square	# 2130B	# 2130S
52 x 110 x 12mm			Square	# 2150B	# 2150S
52 x 145 x 12mm			Square	# 2160B	# 2160S
52 x 165 x 12mm			Square	# 2170B	# 2170S
67 x 90 x 12mm			Square	# 2110B	# 2110S
67 x 60 x 12mm			Square	# 2121	
67 x 180 x 16mm			Square	# 2195	
77 x 210 x 12mm			Square	# 2194	
77 x 110 x 12mm			Square	# 2120B	# 2120S
77 x 160 x 12mm			Square	#2199	
77 x 80 x 12mm			Square	# 2212B	# 2212S
102 x 140 x 12mm			Square	# 2214	
102 x 195 x 12mm			Square	# 2193	
127 x 160 x 12mm			Square	# 2216	
152 x 140 x 12mm			Square	# 2192	



NUTS, BOLTS & WASHERS



DESCRIPTION	PART #	DESCRIPTION	PART #
1/4" nyloc nut galvanised	# 8920	M12 shake proof washer	# 8934
1/4" x 1 1/4" galvanised bolt & nut	# 8941	M12 x 110 galvanised bolt & nut	# 8916
1/2" & 12mm galvanised spring washer	# 8935	M12 x 120 galvanised bolt & nut	# 8915
1/2" galvanised nut only	# 8922	M12 x 130 galvanised bolt & nut	# 8918
1" x 1/4" galvanised bolt only	# 8904	M12 x 130 zinc high tensile bolt/nyloc nut	# 8890
2" x 3/16" galvanised bolt only	# 8902	M12 x 140 galvanised bolt & nut	# 8912
2 1/4 x 7/16" zinc bolt only (caliper mount)	# 8903	M12 x 140 zinc high tensile bolt/nyloc nut	# 8891
3/16" nyloc nut, galvanised	# 8927	M12 x 150 zinc high tensile bolt/nyloc nut	# 8892
5/8" nyloc nut zinc plated	# 8921	M12 x 170 galvanised bolt & nut	# 8913
7/16" zinc flat washer	# 8962B	M12 x 170 zinc high tensile bolt/nyloc nut	# 8893
7/16" zinc spring washer	# 8963B	M12 x 200 galvanised bolt & nut	# 8939
1 1/4" x 1/2" galvanised bolt only (hard point)	# 8901	M12 x 240 galvanised bolt & nut	# 8940
M10 galvanised nut only	# 8923	M12 x 90 galvanised bolt & nut	# 8911
M10 galvanised spring washer	# 8936	M12mm galvanised nut only	# 8924
M10 nyloc nut, galvanised	# 8928	M16 galvanised nut only	# 8925
M10 x 100 galvanised bolt & nut	# 8909	M16 nyloc nut, galvanised	# 8930
M10 x 130 galvanised bolt & nut	# 8910	M16 x 110 galvanised bolt & nut	# 8957
M10 x 25 galvanised bolt & nut	# 8905	M20 flat black washer	# 8964
M10 x 40 galvanised bolt & nut	# 8906	M20 galvanised flat washer	# 8933
M10 x 60 galvanised coach bolt & nut	# 8938	M20 nyloc nut, zinc plated	# 8926
M10 x 65 galvanised bolt & nut	# 8907	M20 x 120 zinc plated bolt & nut	# 8976
M10 x 75 galvanised bolt & nut	# 8908	M20 x 130 galvanised bolt only	# 8917
M12 flat washer, galvanised	# 8931	M20 x 150 galvanised bolt only	# 8919
M12 nyloc nut, galvanised	# 8929	M20 zinc flat washer (axle washer)	# 8932



BOW ROLLER WITH SHAFT & END CAPS - 12mm - BLACK POLY

Standard on most Dunbier Trailers, complete with 12mm

Suits 75mm winch carrier

2892

Suits 100mm winch carrier

2893



BOW ROLLER SET WITH BOLT - YELLOW POLY

75mm size

2886

100mm

2887



BOW V BLOCK - POLY

120mm base width, 'V' 210mm 'V' width. 70mm D x 110mm H.

2979



BOW V BLOCK - RUBBER

100mm width x 55mm depth x 85mm height

2898



WOBBLE ROLLER - GREY - PLASTIC

Standard on Dunbier steel trailers.

110mm H x 75mm W x 22mm hole

2969



WOBBLE ROLLER - LARGE - YELLOW - PLASTIC

Standard on Dunbier Alloy trailers.

127mm H x 75mm W x 31mm hole

2968



WOBBLE ROLLER WASHERS & SPLIT PINS

Size 5mm x 35mm, galvanised finished. Not suitable for #2968.

Display packaged (10 of each per pack)

1679



WOBBLE ROLLER RETAINING CLIPS & WASHERS - LARGE

Suits Alloy wobble roller arm # 2967

2969D

on Dunbier Alloy Series trailers



WOBBLE ROLLER SPLIT PINS

Size 5mm x 35mm, galvanised finished. Not suitable for #2968.

Single split pin

1677

Display packaged (10 per pack)

1678



SELF CENTERING KEEL ROLLER - RUBBER - 6"

153mm L x 53mm Dia.

2975



Shaft to suit - 200mm x 16mm, display packaged

3000S

PARALLEL ROLLER - RUBBER - 6", 8", 12"

145mm L x 60mm Dia.

2901

Shaft to suit - 200mm x 16mm.

Display packaged # 3000S / Bulk # 3000B

200mm L x 60mm Dia.

2902

Shaft to suit - 245mm x 20mm.

Display packaged # 3020S / Bulk # 3020B

295mm L x 60mm Dia.

2903

Shaft to suit - 360mm x 24.5mm.

Bulk # 3040

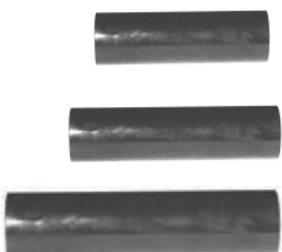



PARALLEL ROLLER - 10" - HARD POLY

252mm L x 55mm Dia.
Shaft to suit - 300mm x 20mm.

2932
Bulk # 3021



ROLLER - DOG BONE - 12" - RUBBER

Lth 305mm x 65mm x 95mm
Shaft to suit - 360mm x 24.5mm

2961
Bulk # 3040



ROLLER - COTTON REEL - 8" - SOFT POLY

Lth 200mm x 50mm x 70mm
Shaft to suit - 245mm x 20mm

2925
Display Packaged # 3020S / Bulk # 3020B



ROLLER - COTTON REEL - 8" - RUBBER

Lth 200mm x 50mm x 70mm
Shaft to suit - 245mm x 20mm

2960
Display Packaged # 3020S / Bulk # 3020B



ROLLER - DOG BONE - 8" - HARD POLY - HEAVY DUTY

Lth 200mm x 45mm x 70mm

#2908BHD

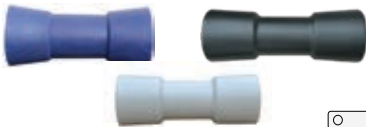

ROLLER - DOG BONE - 8" - HARD POLY

Lth 200mm x 45mm x 70mm BLUE # 2908D / GREY # 2908G / BLACK #2908B
Shaft to suit - 245mm x 20mm

Display Packaged # 3020S / Bulk # 3020B



ROLLER - COTTON REEL - 6" - SOFT POLY

Lth 155mm x 50mm x 75mm
Shaft to suit - 200mm x 20mm

2924
Display Packaged # 3001S / Bulk # 3001B



ROLLER - COTTON REEL - 6" - RUBBER

Lth 155mm x 50mm x 73mm
Shaft to suit - 200mm x 20mm

2909
Display Packaged # 3001S / Bulk # 3001B



ROLLER - DOG BONE - 6" - RUBBER

Lth 155mm x 45mm x 60mm
Shaft to suit - 200mm x 16mm

2950
Display Packaged # 3000S



ROLLER - DOG BONE - 6" - SOFT POLY

Lth 155mm x 45mm x 60mm
Shaft to suit - 200mm x 16mm

2899
Display Packaged # 3000S



ROLLER - DOG BONE - 6" - HARD POLY

Lth 155mm x 45mm x 60mm
Shaft to suit - 200mm x 16mm

BLUE # 2897 / GREY # 2897G
Display Packaged # 3000S

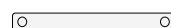

ROLLER - COTTON REEL - 4.5" - RUBBER

Lth 115mm x 55mm x 70mm
Shaft to suit - 160mm x 16mm

2920
Display Packaged # 2990S



ROLLER - COTTON REEL - 4.5" - SOFT POLY

Lth 115mm x 55mm x 70mm
Shaft to suit - 160mm x 16mm

2923
Display Packaged # 2990S



ROLLER - COTTON REEL - 4.5" - HARD POLY



Lth 155mm x 55mm x 70mm BLUE # 2895 / GREY # 2895G
 Shaft to suit - 160mm x 16mm Display Packaged # 2990S / Bulk # 2990B



ROLLER - 4" - RUBBER

Lth 100mm x 45mm x 60mm # 2908
 Shaft to suit - 160mm x 16mm Display Packaged # 2990S / Bulk # 2990B



ROLLER - 3" - RUBBER

Lth 75mm x 35mm x 62mm # 2907
 Shaft to suit - 120mm x 16mm Display Packaged # 2981S / Bulk # 2981B



KNOTT ROLLER - 12" - PVC

16mm, complete with Alloy sleeve # 2962



ROLLER BRACKETS - GALVANISED

Roller bracket suits 4.5" roller # 3235
 Roller bracket suits 6" roller # 3236
 Roller bracket suits 8" roller # 3237
 Roller bracket suits 12" roller # 3238



FRONT 'V' SUPPORT - LOADER PRO HULL - ADJUSTABLE

Bumper block and bracket. 140mm legs. # 3162
 Bumper block and bracket. 250mm legs. # 3163



SINGLE ROLLER & GALVANISED BRACKET - 12"

Rubber roller # 3240
 Roller bracket only # 3239

SINGLE ROLLERS & BRACKETS



4.5"
 Rubber roller # 3232
 Hard poly roller # 3234
 Soft poly roller # 3233



8"
 Rubber roller & bracket # 3145
 Hard poly roller & bracket # 3156H
 Soft poly roller & bracket # 3156



6"
 Bracket only, 140mm legs # 3141
 Bracket only, 250mm legs # 3141L
 Rubber roller & bracket, 140mm legs # 3140
 Hard poly roller & bracket # 3152



10"
 Hard poly roller - blue #3231

DOUBLE ROLLERS & BRACKETS



6"
 Bracket only, double, 140mm legs # 3143
 Rubber rollers & bracket 140mm legs, black # 3142
 Hard poly rollers & bracket 140mm legs, grey # 3153
 Soft poly rollers & bracket 140mm legs, yellow # 3153S



8"
 Rubber rollers # 3146
 Hard poly roller s # 3157H
 Soft poly rollers # 3157



ROLLA-MATIC - DOUBLE

Galvanised, with grey wobble rollers

20mm square leg

40mm square leg

No leg

3100SQ

3100

3102



ROLLA-MATIC - QUAD

Galvanised, with grey wobble rollers

40mm square leg

3110



ROLLA-MATIC - DOUBLE - WIDE

Galvanised, with grey wobble rollers

40mm square leg

3103



KEEL ROLLER GUIDE ASSEMBLY

Galvanised, with grey wobble rollers. Replace existing keel roller brackets with this assembly.

20mm square leg

3106



ROLLER ASSEMBLY KIT - SINGLE WATER VEHICLE TRAILERS

Replace existing pad system with this kit.

Complete as shown, with wobble rollers & brackets to suit

3135



ROLLER ASSEMBLY KIT - 3m - LONG

Galvanised, with wobble rollers and 50mm square tube.

Sold in pairs, complete as shown

3136



ROLLER RAIL ASSEMBLIES - GALVANISED

RAIL LENGTH	ROLLER QTY	SIZE	MATERIAL	PART #
2700mm	10	8"	Hard Poly Rollers	#3044

For a full range of roller rail lengths please refer to the current price list or contact your local Dunbier dealer.



SUPA-ROLLA ASSEMBLY - SINGLE

Adjustable to suit most boat hulls.

Complete as shown with wobble rollers & 40mm square leg

40mm leg, universal bracket and U-bolts only (no roller arms)

3336

3337



SUPA-ROLLA ARMS - SINGLE

300mm long, complete with grey roller
235mm long, complete with grey roller

3260
3260S



SUPA-ROLLA ASSEMBLY - SINGLE

Fully adjustable and ready to mount.

Complete as shown, with grey wobble rollers, bubble plates & U-bolts

3261



#3330 - Rear 8

SUPA-ROLLA ASSEMBLIES - REAR 8, REAR 4, CENTRE 4

Suits Dunbier and most other trailers.

Rear 8 - inc. mounting brackets and U-bolts to fit 50mm cross member

3330

Rear 4 - inc. mounting brackets and U-bolts to fit 50mm cross member

3331

Centre 4 - inc. mounting leg

3332



#3332 - Centre 4



#3331 - Rear 4



ALLOY SUPA-ROLLA ARM & ROLLER

Includes large yellow roller (127mm H x 75mm W x 31mm Hole Dia.)

Alloy arm 300mm L x 27mm H x 19mm W

2967



ALLOY SUPA-ROLLA ASSEMBLY - SINGLE

Adjustable to suit most boat hulls. Complete with 127mm large wobble rollers, lightweight alloy arms and 40mm square leg.

Complete as shown

3342



ALLOY SUPA-ROLLA ASSEMBLY - SINGLE - NO LEG

Fully adjustable arms, ready to mount.

Large wobble rollers, galvanised bubble plate & U-bolts

3334



#3335 - Centre 4

ALLOY SUPA-ROLLA ASSEMBLIES - REAR 8, REAR 4, CENTRE 4

Suits Dunbier and most other trailers with alloy arms. Includes galvanised parallel member, bubble plate, U-bolts and mounting bracket to suit 50mm cross member.

Centre 4 - complete as shown

3335

Rear 4 - complete as shown

3338

Rear 6 - complete as shown

3339

Rear 8 - complete as shown

3340



#3338 - Rear 4



#3339 - Rear 6



#3340 - Rear 8

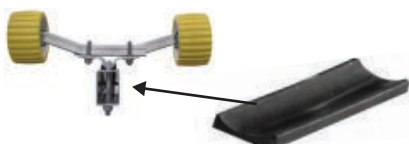

SUPA-ROLLA BUBBLE PLATE RUBBER

Sold by the metre

3060



BUMPER BLOCK - SUITS SUPA-ROLLA

To suit Supa-Rolla arms.
45mm width x 48mm height x 1.5m.

2891B



BUMPER BLOCK - SUITS ALLOY

To suit alloy Rolla arms.
45mm width x 45mm height x 400mm length.

2888

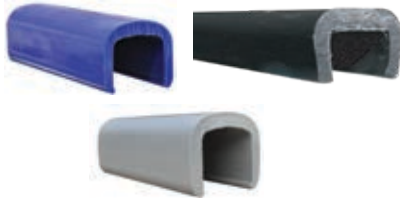

BUMPER BLOCK - SUITS 50sq STEEL TUBES

Suitable for fitting over 50sq steel tube for trailer pads.
Internal size 52mm x 52mm, sold in lengths of 1.5m.

Blue # 2890

Grey # 2890G

Black # 2890B



SLIDE BLOCK - LOADER PRO

Black Plastic W45 x H52 x 650mm R.H.
Black Plastic W45 x H52 x 650mm L.H.

2904

2905



REAR LEAD-IN SECTION - LOADER PRO

Black Plastic W40 x H30 x 730mm

2926



TRAILER PAD STRIP - PLASTIC

45mm x 10mm strip, available in blue, grey or black.

SOLD IN LENGTHS OF	BLUE	GREY	BLACK
1.6m	# 3054	# 3053G	#3055B
3.2m	# 3053	# 3054G	#3055

PADS - STEEL & PLASTIC

3000mm length, 50mm square, galvanised
1330mm length, 50mm square, galvanised
1600mm length, 50mm square, galvanised

3352

3353

3354

PADS - STEEL & PLASTIC - SUITS LOADER SERIES TRAILERS

1330mm length, 50mm square, galvanised
1600mm length, 50mm square, galvanised

3365

3366



PAD - CARPET - SUITS WATER-TOY TRAILERS

Suits water-toy trailers

1600mm length. 70mm x 45mm timber with marine grade carpet.

3359

Suits water-toy trailers

3000mm length. 140mm x 45mm timber with marine grade carpet.

3367



'U' BRACKET FRAME - WELD-ON

Complete with 1/2" bolt and nut, suits 20mm square leg.

Raw metal finish
Galvanised finish

3139
3139G



'U' BRACKET FRAME - BOLT-ON

Complete with galvanised 1/2" bolt and nut.

Suits 20mm square solid steel or tube (bulk)

3138B



SLIDE BRACKETS

Complete with galvanised bolts and nuts.

Fits 50mm x 5mm square tube cross member (bulk)

3252

Fits 50mm x 5mm square tube cross member (display packed)

3252S

Fits 75mm x 50mm tube cross member (bulk)

3253

Fits 100mm x 50mm tube cross member, suits 20mm sq. solid steel or tube

3254

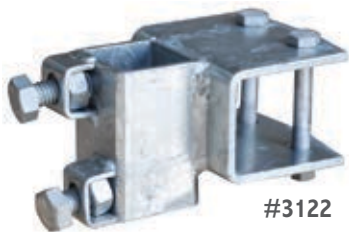

SLIDE BRACKETS - HEAVY DUTY

Complete with galvanised bolts and nuts. Suits 40mm square tube.

Fits 50mm x 50mm square tube cross member, suits 40mm sq. tube

3122

Fits 75mm x 50mm cross members, suits 40mm sq. tube

3123

Fits 50mm x 50mm cross member with single frame bolt, suits 40mm sq. tube leg

3124

Fits 100mm x 50mm cross member with single lock bolt, suits 40mm sq. tube

3125



#3123

#3124

#3125



SLIDE BRACKET - TWO WAY

Complete with galvanised bolts and nuts. Suits 40mm square tube.

Suits 50mm x 50mm square tube, both ways

3305



PAD BRACKETS - 20mm ROUND LEG

Complete with galvanised bolts & nuts. Suits 50mm square tube or timber pad etc.

120mm leg length

3304

190mm leg length

3306



PAD BRACKETS - 20mm SQUARE LEG

185mm leg length, 42mm inside 'U' bracket

3250

185mm leg length, 52mm inside 'U' bracket

3251

250mm leg length, 52mm inside 'U' bracket

3251L



PAD BRACKETS - 40mm SQUARE LEG

170mm leg length, 52mm inside 'U' bracket
250mm leg length, 52mm inside 'U' bracket

3300
3300L

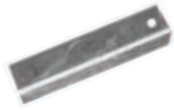

TUBE - 40mm SQUARE LEG

265mm leg length

3131



#9721

#9727

UPRIGHT BRACKETS - TO SUIT LOADER PRO TRAILERS

Square rear tube
Iron angle rear

9721
9727



TWO HOLE PLATE

Suits any 12mm U-bolt that fits over 50mm wide tube

3291



'D' SHACKLES

10 mm, L58 x W37 x 19 inside x 10mm (bulk)
10 mm, L58 x W37 x 19 inside x 10mm (display packaged)

5632B
5632C



'D' SHACKLES - RATED

10 mm rated 'D' shackle
10 mm rated 'D' shackles (display packaged)
12 mm rated 'D' shackles
13 mm rated 'D' shackle

5630
5630C
5633
5672



'R' CLIPS

Small 'R' Clip L44 x W14 x 2mm (bulk)
Small 'R' Clip L65 x W22 x 3mm (bulk)
Medium 'R' Clip L76 x W25 x 4mm (bulk)
Medium 'R' Clip (sold in pairs and display packed)
Large 'R' Clip L118 x W42 x 6mm (bulk)

8974
8999
1360
1360C
8950



BOLT-ON GALVANISED SAFETY CHAIN

Including bolt & nut

10mm x 610mm
13mm x 620mm

1021
1022



GALVANISED SAFETY CHAIN - WELD ON

8mm x 500mm (12 Links)
10mm x 610mm (12 Links)
13mm x 620mm (13 Links)

1018
1019
1020



SPARE WHEEL COVERS

Back vinyl and white writing.

To suit 13" wheel

1520

To suit 14" wheel

1521



WHEEL CLAMP - LOCKABLE

Heavy duty steel construction anti-theft device, with push to lock mechanism, suits most wheels 13"-15". Lock and key included.

Complete as shown

1534

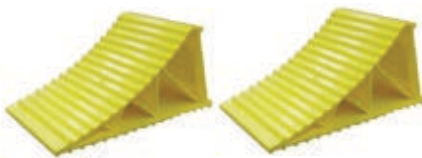

PLASTIC WHEEL CHOCKS

Easy to use and light for convenient storage. Sold in pairs.

Complete as shown

1524



COUPLING LOCK - TRAIL-SAFE

Designed to lock your trailer either on or off the vehicle, Includes a heavy duty pad lock.

Complete as shown, display packed

1522



GLIDER KIT - SELF CENTRING SYSTEMKIT

Dramatically improve your retrieving by ensuring your boat is centred every time. Suits most boat trailers. Complete as shown and display packaged.

Suits 50 x 50mm cross member

3108

Suits 75 x 50mm cross member

3109



KIT INCLUDES



Note: roller rail and keel rollers not included.



CENTRELINE KIT - SELF CENTRING SYSTEM

Dramatically improve your retrieving by ensuring your boat is centred every time. Includes 20mm square leg mount. Complete as shown and display packaged.

Suits #3252 slide frame mount

3093



TRAILER PADS - PLASTIC

300mm length, grey

3346

TRAILER ACCESSORIES



HEAVY DUTY TIE-DOWNS - TRANSOM PACK

270kg load rating, display packed, complete as shown, pair.

1.5m length x 50mm web width

3955



HEAVY-DUTY TIE-DOWN - OVER BOAT SYSTEM

270kg load rating, display packed, complete as shown, single.

5.5m length x 50mm web width

3957



MEDIUM-DUTY TIE-DOWNS - 2 PK

700kg breaking strength, display packed, complete as shown, pair.

280mm-1,220mm adjustable length x 25mm web width

3974



LIGHT DUTY OVERCENTRE RATCHET TIE-DOWN

NZ made overcentre/gunwale tie-down for securing light boats to trailers. Breaking strength 450kg. Single pack.

4m length x 25mm width, PVC coated S-hooks

3930



ENDLESS HOOK TO HOOK RATCHET TIE-DOWN

For securing jet skis & small boats to trailers.

Breaking strength 800kg. Comes as a pair.

0.9m length x 25mm width, floating PVC coated S-hooks

3931



RATCHET OVER BOAT TIE-DOWN

800kg load rating. Complete as shown, display packed.

1.5m length x 25mm web width

3934



TRANSOM RATCHET TIE-DOWNS - STAINLESS STEEL

For securing boats to trailers at the transom/stern of the boat.

800kg breaking strength. Comes as a pair.

1.5m length x 25mm wide, PVC coated S-hooks

3937



TRANSOM RATCHET TIE-DOWNS - HEAVY DUTY

For securing medium/large boats to trailers at the transom/stern of the boat.

1,500kg breaking strength.

1.2m length x 50mm wide, PVC coated S-hooks

3940



RUBBER TIE DOWN STRAP & HOOKS

250mm (10") length

380mm (15") length

3950

#3951



TIE-DOWN MOUNT - TRAILER

Galvanised, adjustable, complete with bolt & nut

To suit 75mm x 50mm RHS

To suit 100mm x 50mm RHS

#3255

#3256



OUTBOARD MOTOR SUPPORT BRACKET - UNIVERSAL

To suit smaller outboards up to 60hp. Display packed.

Adjustable to suit most outboard motors

3915

Optional mount bracket to suit

3916



OUTBOARD MOTOR SUPPORT - MOTORFLEX

Suits trailers with fixed rear cross members.

Adjustable to suit most outboard motors, includes strap

#3926



OUTBOARD MOTOR SUPPORT ASSEMBLY - MOTORFLEX

Suits trailers with fixed rear cross members.

Adjustable to suit most outboard motors, includes strap

#3927



DUNBIER TRAILER GUIDE POLE SET

Suits most boat trailers. Galvanised finish, with wobble roller on the top for protection of the boat. Includes mounting hardware.

Fully adjustable universal guide pole kit

8080



KAYAK CARRY BARS

Upgrade your kayak trailer to carry two kayaks with optional carry bars.

To suit Dunbier Nipper series trailers

3160

To suit Dunbier Spark series trailers

3161



8108

1536

L&R BOAT LATCH ADAPTOR PLATES

Suits fibreglass

8108

Suits Loader Pro series

1536



DUNBIER LOCKABLE JERRY CAN HOLDER

Suits 75mm-100mm deep trailer side frames. Display packed.

Heavy-duty, galvanised steel construction, includes all mounting hardware.

Heavy-duty lockable jerry can holder

3920



SIDE FRAME DECALS

Small side frame sticker, suits 75mm depth

8103

Large side frame sticker, suits 100mm depth

8104



GUARD DECALS

Sold in pairs

8105



DUNBIER DECAL SET

Includes 2 x side frame stickers and 2 x mudguard stickers.



Suits trailers up to 5.0m

8113



Suits trailers from 5.3m

8114



WWW.DUNBIER.COM

