



ACCESSORIES CATALOGUE

2019

50

years
1969 - 2018
Still family owned



MELBOURNE, VIC (HEAD OFFICE)

136-164 Boundary Road, Braeside, VIC 3195
PH: (03) 9580 2455
E: sales@dunbier.com



BRISBANE, QLD

PH: (07) 5540 7477
E: dunbqld@dunbier.com



SYDNEY, NSW

PH: (02) 9618 0100
E: dunbnsw@dunbier.com



ADELAIDE, SA

PH: (08) 8250 4557
E: dunbsa@dunbier.com



PERTH, WA

PH: (08) 9437 9689
E: dunbwadunbier.com

NEW

at Dunbier

KNOTT



ALL NEW JOCKEY WHEELS
Added to the Dunbier Range!
European designed Jockey Wheels and Components. Find out more on page 4.

ALLOY **Foldaway Trailer**



FUCHS Wheel Bearing Grease



Mechanical Disc Caliper Pads



Dunbier **Sticker Kit**



Galvanized Walkways

4.7/5.0/5.3M

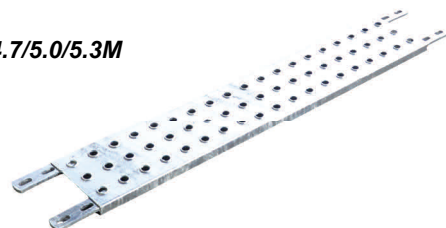

INDEX

A

Aluminium Launch & Retrieve	3
Alloy Bumper Block	41
Axle Nuts & Washers	20
Axle Saddles	24
Axles	25- 27
Axles Duratorque	27

B

Battery Boxes	46
Battery Strap	46
Beach Loader System	42
Bearing Buddies	19
Bearing Grease	22
Bearing Protectors	19-20
Bearing Sets	21
Boat Latch	3
Bolts	48
Bow Rollers	36
Brake Cable	30
Brake Calliper	23
Brake Cable Clamps	30
Brake Controllers	31
Brake Hose	29
Brake Kits	24
Brake Lines & Kit	28
Brake Pads	29
Brake Components	28- 31
Brake Couplings	6
Bumper Block	41

C

Cable Ties & Clamps	15
Cable Wire	15
Calliper Replacement Parts	29-30
Callipers	23
Caps - Winch Posts	44
Cable Looms and Car Plugs	14-15
Carpet Pads	42
Centreline Systems	42
Coupling Balls	6
Coupling Locks	6
Coupling Spare Parts	6
Couplings	6
Cross Members	44
Cross Member Stop (Rear)	44
Chain Safety	6

D

D Shackles	46
Disc Hubs	22- 23
Disc Pads	29
Dunbier Trailer Stickers	48
Dust Caps	20
Drop Down Spare Wheel Mount	19

E

Electric Hydraulic Brakes	31
---------------------------	----

F

Fibreglass Launch & Retrieve	3
Fish Plates	33
Fold Away Trailer	47
Fulton Winch	10

G

Glider Trailer Kit	42
Guide Poles	11

H

Hand Brake Levers	30
Hand Winches	9
Hydrastar Brake Assemblies	31
Hydrastar Braking Spare Parts	30-31
Hydraulic Brake Parts	29-30
Hydraulic Brake Line Joiners	30
Hydraulic Master Cylinder	30
Hydraulic Unions	30
Hubs	22-23

J

Jerry Can Holders	11
Jockey Wheels	4-5
Jockey Wheel Replacement	4-6
Jockey Wheels KNOTT	4
Jockey Wheel Mount Plate	6

K

Keel Rollers	37-38
Knott Jockey Wheels	4
Knott J/W Replacement parts	4

L

Launch & Retrieving System	3
Lazy Axles	25-27
LED Lights	12-13
Light Boards	13
Licence Plate Brackets	13
Light Kits	12
Load Share Spring Assemblies	32
Locks: Coupling	6

M

Mechanical Brake Levers	30
Mount Brackets, Pads & Slides	43- 44
Motor Outboard Support Brackets	11
Mudguard Carriers	34- 35
Mudguards & Mudflaps	33-34
Mudguard Foldaway	47

N

Number Plate Bracket	13
Nuts & Bolts	48

O

Oil Seals	21
Outboard Motor Supports	11

P

Pack Rack	47
Pad Brackets & Legs	43-44
Plastic Mudguards	34
Poly Rollers	36-37
Poly Pads	41-42

R

Ratchet Tie Downs	7-8
Replacement Cross Members	44
Rear Cross Member Assemblies	44
R Clips	46
Reflectors	13
Retaining Clips (Wobble Roller)	36
Retractable Tie Downs	8
Rollamatic Assemblies	39-40
Roller Rail Beds	35
Roller Brackets	38-39
Roller Pins	36
Rollers	36-39

S

Safety Chain	6
Shackle Bolts	32
Shackle Bushes	32
Spare Wheel Carriers	19
Spare Wheel Covers	18
Split Pins	20
Spring Hangers	33
Spring Kits	32
Springs & Components	32-33
Stub Axles	24
Swing Drawbar Kits & Drop Pin	46
Seals: Axles	21
Slide Brackets	43
Stickers	48
Sticker Kit	48

T

Teflon Strips	41
Tie Down Trailer Mounts	7
Tie Downs	7-8
Tow Balls	6
Trailer Axles	25-27
Trailer Bearings	21
Trailer Safety Chain	6
Trailer Coupling Lock	6
Trailer Electric Plugs	14-15
Trailer Grease	22
Trailer Hubs	22-23
Trailer Light Cover Plate	13
Trailer Lighting	12-15
Trailer Swing Drawbar Kit	46
Trailer Plug Adaptors	15
Transom Tie Downs	7-8
Tyres	16-18
Teflon & Steel Skids	41

U

Ubolts	33
--------	----

W

Walkways	35
Wheel Chocks	18
Wheel Nuts	20
Wheel Studs	20
Wheel & Tyres	16-18
Wheels & Covers	18
Winch Cables/Straps	10
Winch Post Caps	44
Winch Carriers	45-46
Winch Handles	9-10
Winch Parts	9-10
Winch Posts	45
Winch Straps	10
Winches	9-10

TRAILER EQUIPMENT

Launch + Retrieve Boat Latch TO SUIT ALLOY & FIBREGLASS BOATS TO 6M



Aluminium Latch

L & R™ Boat Latch on Towing Eye (Aluminium) boat

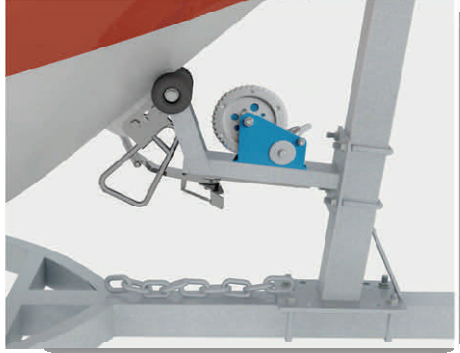

Fibreglass Latch

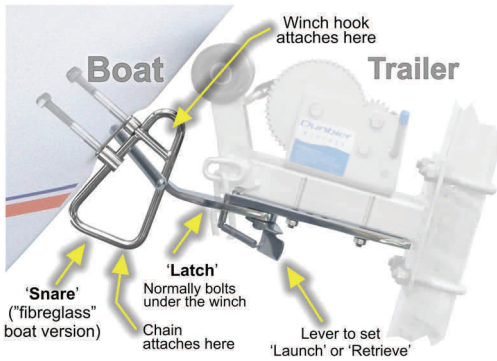

CODE	DESCRIPTION
8100	L&R Alloy Boat Latch (In box supplied)
8099	L&R Alloy Boat Latch (Fitted to trailer)
8097	L&R Fibreglass Boat Latch (In box supplied)
8098	L&R Fibreglass Boat Latch (Fitted to trailer)
8108	L&R Boat Latch Adaptor Plate Fibreglass

- **Launch and Retrieve your boat without getting wet**
- **Easy to install and covers aluminum, plate aluminum, and fiberglass boats up to 6m**

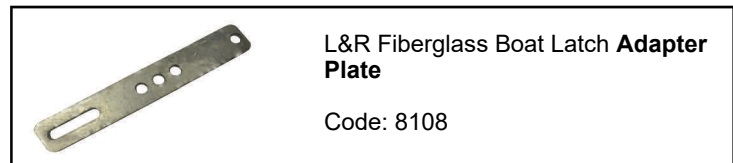

Marine Grade - high strength - Stainless Steel

Special note: L&R Boat Latch is not intended for road travel. Only use for the boat ramp.

ATV Trailers

- **General Cartage**
- **Golf buggies**
- **Motorbikes**

CODE: 9294



Chassis Size: 2500 x 1550 (8x5)

Inner size: 2450 x 1500

O/A Length: 3800

O/A Width: 1980

Tail Gate Height: 500

- 165 Tyres
- LED Lighting
- Swing up/ Wind down Jockey Wheel
- 50mm coupling

CODE: 9297



Chassis Size: 2900 x 1770 (9x5)

Inner size: 2840 x 1700–
Brake Model 1200KG Rating

O/A Length: 4500

O/A Width: 2260

Tail Gate Height: 500

- 155R-13C HD Tyres
- LED Lighting
- Swing up/ Wind down Jockey Wheel
- 50mm coupling



*European Designed
HIGH QUALITY JOCKEY
WHEELS*

Made in Hungary, and known as the highest quality Swing Away Jockey Wheel on the market. Knott is finished in a galvanized coating for longevity in the marine market.

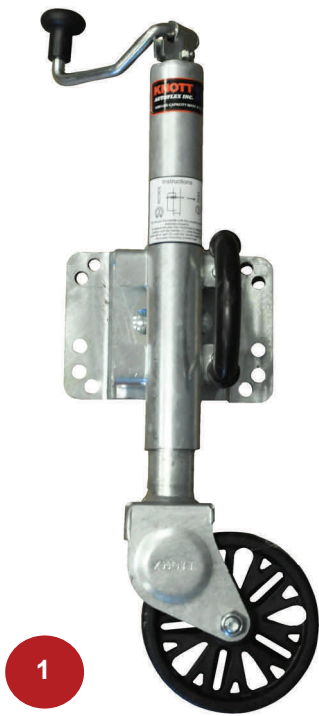

1



2



3



4



5



6



7

No.	Code	Description	Load Cap	Lift Height	Wheel Size
1	1299	Knott Swing Up J-Wheel 6"	545kg	211	150x47mm
2	1293	Knott Swing Up J-Wheel	545kg	255	210x50mm
3	1294	Knott Swing Up J-Wheel	545kg	255	210x75mm
4	1295	Knott Handle Suits 1293/1294	-	-	-
5	1296	Knott Replacement Wheel	-	-	210x75mm
6	1298	Knott Replacement Wheel	-	-	210x50mm
7	2962	PVC Roller 12" with Alloy Sleeve	-	-	-

TRAILER EQUIPMENT



FULTON Heavy Duty 725Kgs Lift Capacity.

Alloy construction, single wheel, separate adjustable height.

Complete as shown.

Replacement wheel Suits: Dual wheel

Replacement wheel Suits: Single wheel

Replacement gear set & roll pins.

Replacement crank handle kit.

Replacement T Handle.

1287

1354

1354S

1355

1353

1356

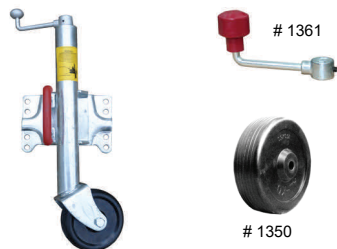

Jockey Wheel Wind-Up Swing-Up 350Kgs Lift Capacity.

Features: 150 x 50mm rubber wheel.

Fully galvanized and complete as shown.

Replacement solid wheel 150 x 50mm.

Replacement crank handle. Suits All

1292

1350

1361



Wind-Up Swing-Up 350Kgs Lift Capacity.

Features: 200 x 60mm steel and rubber wheel.

Complete as shown.

Replacement wheel 200 x 60mm.

1262

1351



Wind-Up 350Kgs Lift Capacity.

Features: 150 x 50mm rubber wheel.

Jockey wheel with clamp as shown.

Jockey wheel less clamp.

Replacement solid wheel 150 x 50mm.

1290

1300

1350



Wind-Up 350Kgs Lift Capacity.

Features: 250 x 85mm steel and rubber wheel.

Jockey wheel with clamp as shown.

Replacement wheel 250 x 85mm.

1312

1352



Replacement 6" Rubber Wheel.

Solid rubber wheel, complete with locking R Clip.

250 Kgs weight capacity.

Replacement solid rubber wheel.

Replacement R Clip.

1350

1360

TRAILER EQUIPMENT

Mounting Bracket For **FULTON** Jockey Wheel.

This galvanized bracket has been designed for larger drawbars where the standard mounting kit does not suit.

Suits 100-150mm deep drawbars and Includes Ubolts.

1286

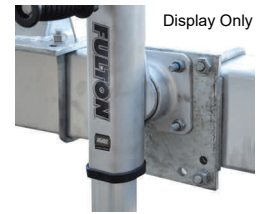

Trail-Safe Coupling Lock.

Designed to lock your trailer either on or off the vehicle, Includes a heavy duty pad lock.

Complete as shown, display packed.

1522



Standard 50mm Trailer Coupling.

Galvanized finish with 2000kgs towing capacity with optional ball head adjusting bolt.

Complete as shown.

Replacement adjusting bolt,

Replacement trigger assembly kit.

1010

1011

1044c



1044c



Heavy Duty 50mm Trailer Coupling.

Galvanized finish with 3500kgs towing capacity with Optional ball head adjusting bolt.

Complete as shown.

Replacement adjusting bolt.

1000

1011



Heavy Duty 70mm Trailer Coupling.

Painted finish with 4500kgs towing capacity.

Coupling complete with 70mm towball.

Coupling only, less 70mm towball.

70mm towball only.

1015

1014

1045



1045



Hydraulic Over-Ride 50mm Trailer Coupling.

Galvanized finish with 2000kgs towing Capacity.

Coupling complete as shown, no towball.

Coupling 50mm towball to suit.

Replacement master cylinder and hand break assembly.

Replacement reverse stop and bolt.

1030

1061

1029

1042c



1029

1042c

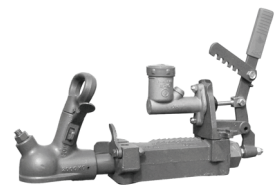

Mechanical Over-Ride 50mm Trailer Coupling

Galvanized finish with 2000kgs towing capacity.

Note: towballs are not supplied with couplings

Coupling 50mm towball to suit.

Replacement adjusting bolt.

Replacement reverse stop and bolt.

1041

1061

1011

1042c



1061



Mechanical Over-Ride 50mm Trailer Coupling

Galvanized finish with 3500kgs towing capacity.

Note: towballs are not supplied with couplings

Coupling 50mm towball to suit.

Replacement adjusting bolt.

Replacement reverse stop and bolt.

1032

1061

1011

1042c



1061



Heavy Duty Safety Chain

Herc Alloy 13 links x 13mm x 500mm long, galvanized.

Two required for trailers 3.5 - 4.5 tonne.

Complete as shown.

1017



TRAILER EQUIPMENT

Tiedowns can be customised by you! Speak to us today about getting your company name weaved into these New Zealand made Quality Tiedowns. (Quantity restrictions apply).



Light Duty Overcentre Ratchet Tiedown

Single Pack. Overcentre / Gunwale Tiedown for securing Light boats to trailers. Breaking strength 450kg
4M Long x 25mm wide with PVC Coated S-Hooks.

3930



Endless Hook to Hook Ratchet Tiedown

Pair. For securing Jet skis/ small boats to trailers. Breaking strength 800kg
0.9M Long x 25mm wide with Floating PVC Coated S-Hooks.

3931



Transom Ratchet Tiedowns

Pair. For securing boats to trailers at the transom/ stern of the boat. Breaking strength 800kg
1.5M Long x 25mm wide with PVC Coated S-Hooks.

3934



Transom Ratchet Tiedowns- Stainless Steel

Pair. For securing boats to trailers at the transom/ stern of the boat. Breaking strength 800kg
1.5M Long x 25mm wide with PVC Coated S-Hooks.

3937



Transom Ratchet Tiedowns- Heavy Duty

Single Pack. For securing medium / large boats to trailers at the Transom / stern of the boat. Braking strength 1400kg
5.5M Long x 50mm wide with PVC Coated S-Hooks.

3938



Transom Ratchet Tiedowns- Heavy Duty

Pair. For securing medium / large boats to trailers at the Transom / stern of the boat. Braking strength 1500kg
1.2M Long x 50mm wide with PVC Coated S-Hooks.

3940

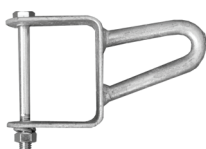

Galvanized Adjustable Trailer Tie-Down Mounts.

Two sizes available complete with bolt & nut.

Suits: H75 x W50mm trailer side frames.

3255

Suits: H100 x W50mm trailer side frames.

3256

TRAILER EQUIPMENT

All Tie-downs come display packed in retail packaging

Padded Tie-Down Covers.

Features: Built in Velcro straps for easy installation.
Complete as shown, display packed, sold in pairs.

3959



Transom Retractable Ratchet Tie-Down.

Construction: Stainless Steel & Plastic , Strap W50 x L100mm
Strap retracts for easy storage and no tangling.
Easy bolt on function (Hardware included)
Vinyl coated J-hooks protect boats finish..
Load Rating 400kg.

3966



Ratchet Over Boat Tie-Down.

5.5M long x web width 50mm.
Complete as shown, display packed.
Load Rating 270kg.
Includes J Hook for easier use.

3957



Camlock Over Boat Tie Down

5.5M long x web width 50mm.
Complete as shown, display packed.
Load Rating 270kg.

3958



Ratchet Ski Hook Tie-Downs.

Web width 50mm, adjustable from 280-1220mm
Complete as shown, display packed, sold in pairs.
Load Rating 270kg.

3955



Ratchet Ski Hook Tie-Downs.

Web width 25mm, adjustable from 280-1220mm.
Complete as shown, display packed, sold in pairs.

3974



Rubber Tie-Down Strap & Hooks.

Length: 250mm (10").
Length: 380mm (15").

3950

3951



TRAILER EQUIPMENT

Dunbier Winches

Suitable for retrieving boats up to 25 feet in length, the Dunbier Winch Range of marine winches are available in five different sizes:
3-1, 5-1, 5-1 1-1, 10-1/ 5-1/1-1, 15-1/ 5-1/ 1-1.
Load capacity ratings are from 500kg to 1500kg.



Light Duty 3:1 Winch & Strap.

Dacromet coated for longer life 300kgs capacity.

Winch and strap as shown.

1138



3:1 Winch & Strap.

Dacromet coated for longer life 500kgs capacity.

Winch and strap as shown.

Replacement winch pawl kit.

1160G

7198



5:1 Winch & Strap.

Dacromet coated for longer life 700kgs capacity.

Winch and strap as shown.

Replacement winch pawl kit.

1161G

7198



Two Speed 5:1/1:1 Ratio Winch & Strap.

Dacromet coated, 700kgs capacity, includes handle.

Winch and strap as shown.

Replacement winch pawl kit.

Replacement winch handle.

1162G

7198

1200



Three Speed 10:1/5:1/1:1 Ratio Winch & Strap.

Dacromet coated, 800-1000kgs capacity, includes handle.

Winch and strap as shown.

Replacement winch pawl kit.

Replacement winch handle.

1163G

7197

1200

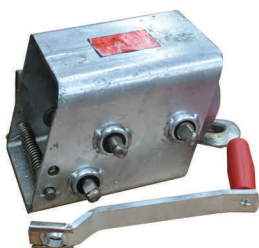

Three Speed 15:1/5:1/1:1 Ratio Winch & Strap.

Galvanized 1200kgs capacity, includes handle.

Winch and strap as shown.

1176

Fulton Winch– 1600LB

FULTON F2 Winch with a 727kg capacity.
Includes handle, winch and strap as shown.

1130



WINCH REPLACEMENT PARTS

Replacement Winch Handles.

Replacement Alko handle.

1210



Replacement Winch Handles.

Replacement Hex handle.

1200



Replacement Winch Cables.

Replacement cable with S hook 6M x 4mm.

1180

Replacement cable with S hook 8M x 5mm.

1183

Replacement cable with S hook 6M x 5mm.

1190



Replacement Winch Strap.

Complete with S hook 6M x 50mm width.

1192



Replacement Winch Strap With Wire Tail.

This strap is designed to replace a cable on a cable winch.

Complete with S hook 4.5M x 50mm width.

1193



Replacement Winch Strap.

Complete with snap hook 7.5M x 50mm width.

1194



TRAILER EQUIPMENT



Universal Outboard Motor Support Bracket.

Suits smaller outboards up to 60hp, display packaging.
Adjustable to suit most outboard motors.
Optional mount bracket to suit.

3915
3916



Outboard Motorflex Motor Support

Suits 50 x 50 cross-members.
Suits Sports / Centreline / Glider Series
ADJUSTABLE WIDTH

3925



Outboard Motorflex Motor Support.

Suits trailers with fixed rear cross members.
Adjustable to suit most outboard motors. Includes strap.

3926



Outboard Motorflex Motor Support Assembly.

Suits trailers with fixed rear cross members.
Adjustable to suit most outboard motors, Includes strap.

3927

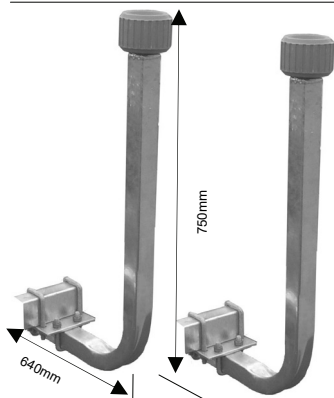

DUNBIER Trailer Guide Pole Set.

Fully adjustable universal guide pole kit, suits most boat trailers
Galvanized finish has wobble roller on the top for protection for the boat,
includes all mounting hardware, sold in pairs.

8080



DUNBIER Lockable Jerry Can Holder.

Galvanized, includes all mounting hardware, heavy duty.
pad lock, suits 75mm - 100mm deep trailer side frames.

3920



- ✓ **ADR Approved**
- ✓ **Exclusive to Dunbier**
- ✓ **Waterproof Submersible Lights**
- ✓ **Available in aftermarket**
- ✓ **Retail Packaging**
- ✓ **Used on all current Dunbier Boat Trailers**

DUNBIER LED Lamp Kit 7.0M

(Trailer Ready Bulk)

Standard for most trailers. Includes side marker lamps, Left and right hand lamps, fully loomed, quick install, Suits trailers up to 6M.

2458



DUNBIER LED Lamp Kit 10.0M

(Trailer Ready Bulk)

Standard for most trailers. Includes side marker lamps, Left and right hand lamps, fully loomed, quick install, Suits trailers up to 8M.

2459



DUNBIER 8M Lamp Kit

Includes Side Lamps Blister Pack.

Fully loomed with 8M of cable. Right and left hand lamps, Complete with license plate lamp, in retail display pack.

2467

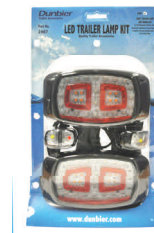

DUNBIER L & R Lamps Only

Right and left hand lamps, complete with license plate lamp. Sold in pairs and comes packaged in blister pack.

2468



DUNBIER LED Lamp L.H

Size: 202W x 110H x 23D

Includes Indicator, Stop/Tail and all mounting hardware. Sold Individually. Bulk Pack.

2481



DUNBIER LED Lamp R.H

Size: 202W x 110H x 23D

Includes Indicator, Stop/Tail and license plate lamp. Sold Individually. Bulk Pack.

2482



TRAILER EQUIPMENT



Light Board With LED Lamps

Plastic board 1.5M long with 8.5M of cable lead and plug.

2480

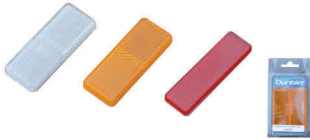

Reflectors Self Adhesive.

White: L70 x W 28mm, clam pack and sold in pairs.

2451S

Amber: L70 x W 28mm, clam pack and sold in pairs.

2452S

Red: L70 x W 21mm, clam pack and sold in pairs.

2453S



Metal Trailer Lamp Cover.

Standard on Dunbier trailers.

Punched holes suit a large combination of lamps .

2496



Universal Rubber License Plate Bracket

Suits: Most Trailer Tail Lamps

2497



Replacement Led Lamps With 200mm WireTail.

Right Hand: Includes license plate lamp

2447

Left Hand.

2448



Compact Trailer Submersible Led Lamp.

Right hand Lamp. Size: W150 x H105 x D27mm.

Complete with license plate lamp and built in reflectors

Includes all mounting hardware.

2464



Compact Trailer Submersible Led Lamp.

Left hand Lamp. Size: W150 x H80 x D23mm.

Includes built in reflectors and mounting hardware.

2465



Led Amber/Red Side Marker Lamp.

Includes snap in base and wire tail.

2478



Led Amber Side Marker Lamp

Includes snap in base and wire tail.

2474



DUNBIER Led Amber/Red Side Marker Lamp.

Includes snap in base-wire tail with plug.

2479

Replacement Trailer LED Twin Loom Connector

Suits all Dunbier trailers with LED lamp wiring looms. # 2784



Clear Flat 7 Pin Trailer Plug

Features: Colour Coded Wiring Screws
Used in NSW and most other states.Suits vehicle female socket # 2852. # 2851



Steel Flat 12 Pin Trailer Plug

Features: Colour Coded Wiring Screws
Used in NSW and most other states.Suits vehicle female socket # 2836. # 2837



Steel 12 Pin Vehicle Base

Features: Colour Coded Wiring Screws
Used in NSW and most other states.Suits vehicle female socket # 2837. # 2836



Steel 7 Pin Trailer Plug

Features: Colour Coded Wiring Screws
Used in Vic & SA: Suits vehicle female socket # 2835. # 2834



Clear Round 7 Pin Trailer Plug.

Features: Colour Coded Wiring Screws
Victoria and South Australia. Suits vehicle female socket # 2820 & # 2835 # 2830



Clear Small Round 7 Pin Trailer Plug.

Features: Colour Coded Wiring Screws
Plastic finish: Used in QLD and W.A. # 2855



Round 7 Pin Vehicle Socket.

Plastic finish: Suits trailer plug # 2830. # 2820



Round 7 Pin Vehicle Socket.

Metal finish: Suits trailer plug # 2830. # 2835



TRAILER EQUIPMENT



Flat 7 Pin Vehicle Socket.

Suits vehicle male plug # 2851.

2852

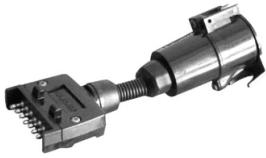

Trailer Adaptor Plug.

Suits vehicle female flat socket,
2852 to large 7 pin round # 2830.

2770



Trailer Adaptor Plug.

Suits vehicle female flat socket,
2852 to small round # 2855

2810



Trailer Cable 5 Core Flex.

Cable roll: 30M.
Cable roll: 100M.
Cable roll: 1000M

2860R
2863R
2859



Trailer Cable 7 Core Flex.

Cable roll: 30M.

2864R



Trailer Cable.

Twin wire cable: 30M.

2862R



P-Clips.

3/16th Nylon cable clamps, sold per 100.
Ideal for chassis mounting brakes lines

2871



Black Cable Ties.

100mm (4")long (sold per 100).
200mm (8")long (sold per 100).
300mm (12")long (sold per 100).
370mm (14.5")long (sold per 100).

2730
2740
2750
2751

TRAILER EQUIPMENT

Galvanized Steel Rim And Tyre 400 x 8.

Suits: Foldaway from February 2010...NOTE: Special 140mm dia Hub to Suit this Rim : Dunbier # 1649
Rim and Tyre. Load capacity 268kgs. # 1449
Rim Only (No Tyre) 8 x 3.75. # 1504
400 x 8 Tyre and Tube. # 1381



Galvanized Multi-Fit Steel Rim And Tyre 500 x 10.

Multi Fit Rim: Suits Ford or HT Holden, PCD 108 & 114mm.
Steel Rim and Tyre. 437kgs capacity. # 1404
Steel Rim Only (No Tyre). # 1481
500 x 10 Tyre and tube. # 1400



Galvanized Steel Rim And Tyre 155RLT x 13.

Suits Ford PCD 114mm.
Steel Rim and Tyre. 600kgs capacity. # 1461
Powder Coated White Rim and Tyre. (Not Shown) # 1461W
Steel Rim Only (No Tyre). # 1492
155RLT x 13 Tyre. # 1462



Galvanized Steel Rim And Tyre 165/70R x 13.

Suits Ford PCD 114mm.
Steel Rim and Tyre. 600kgs capacity. # 1469
Steel Rim Only (No Tyre). # 1492
Note: Tyre is not sold separate.



Galvanized Steel 13"Rims & Tyres 175R13LT.

Suits Ford PCD 114mm.
Galvanized Steel Rim and Tyre. 690kgs capacity. # 1467
Powder Coated White Rim & Tyre, Not shown. # 1467W
Steel Rim Only (No Tyre). 754Kgs capacity # 1492
Powder Coated White Rim (No Tyre), Not shown. # 1494
175R 13LT Radial Tyre. # 1466



Galvanized 13" Multi-Fit Steel Rim And Tyres.

Multi-Fit Rim: Suits Ford or HT Holden, PCD 108 & 114mm.
Steel Multi-Rim & ST175/80R x 13 Tyre. 615kgs capacity. # 1464
Steel Multi-Rim & 155RLT x 13 Tyre. 600Kgs capacity. # 1459
Steel Multi-Fit Rim Only (No Tyre). 754Kgs capacity # 1491



Galvanized 14" Multi-Fit Steel Rim And Tyres.

Multi-Fit Rim: Suits Ford or HT Holden, PCD 108 & 114mm.
Steel Multi-Rim & 185/R14C Tyre 850kgs capacity. # 1506
Steel Multi-Fit Rim Only # 1490



TRAILER EQUIPMENT



Galvanized 14"Steel Rims & Tyres 185R14C.

Suits Ford PCD 114mm.
Steel Rim & Tyre. 840kgs capacity. # 1472
Powder Coated White Rim & Tyre. Not shown. # 1472W
Steel Rim Only (No Tyre). 850kgs capacity. # 1493
Powder Coated White Rim (No Tyre). Not shown. # 1495
185R14C Radial Tyre Only. # 1468



Galvanized 14"Steel Rims & Tyre 195R14C.

Suits Ford PCD 114mm.
Steel Rim & Tyre. 950kgs capacity. # 1482
Powder coated white Rim & Tyre. Not shown. # 1483
Steel Rim Only (No Tyre). 850kgs capacity. # 1493
Powder coated white Rim (No Tyre), Not shown. # 1495
195R14C Radial Tyre. # 1470



Galvanized Spoke Wheel 14" 6 Stud.

Suits Landcruiser Stud Pattern.
Steel Rim Only. # 1496
Rim & 195R14C Tyre 950Kgs capacity # 1497



Galvanized Steel 6 Stud Rim & Tyre 15".

Steel Rim: PCD 140mm. Suits Landcruiser.
Steel Rim & P225/70 x 15 Tyre. 1100kgs capacity. # 1509
Steel Rim Only (No Tyre). 1180Kgs capacity # 1512



NEW

Galvanized Steel 13" Rim & Tyre. 195/50/13

195/50R13C x 13 Tyre Only. 900kgs capacity. # 1456
13" x 195 / 50R13C Radial Tyre & Gal Wheel. # 1457



NEW

Black Knight Alloy Rim. 195/50/13R Tyre

13" x 195 / 50 Black Knight Alloy Rim. # 1458

13" DUNBIER Alloy Rim & Tyres.

Suits: Ford PCD 114mm.

Alloy 13" Rim & Tyre 175/80R13	615kgs capacity.	# 1451
Alloy 13" Rim & Tyre 175R13LT.	690kgs capacity.	# 1454
Alloy 13" Rim & Tyre 155RLT13	600Kgs capacity.	# 1455
Alloy 13" Rim Only (No Tyre).	830Kgs capacity.	# 1501

14" DUNBIER Alloy 5 Stud Rim & Tyres.

Suits: Ford PCD 114mm.

Alloy 14" Rim & Tyre 185/14C	840kgs capacity.	# 1452
Alloy 14" Rim & Tyre 195/R14C	950kgs capacity.	# 1505
Alloy 14" Rim (No Tyre).	1050kgs capacity.	# 1502

14" & 15" DUNBIER 6 Stud Alloy Rims & Tyre.

Alloy Rim: PCD 139.8mm. Suits Landcruiser.

Alloy Rim & P225/70 x 15 Tyre.	1100kgs capacity.	# 1453
Alloy 14" Rim & Tyre 195/R14C	950kgs capacity	# 1510
Alloy Rim 15" Only (No Tyre).	1100Kgs capacity	# 1503
Alloy Rim 14" No Tyre	1100kgs capacity	# 1508



13" Black Knight Alloy Rim & Tyres.

Suits: Ford PCD 114mm.

Alloy 13" Rim & Tyre 175/80R13	615kgs capacity.	# 1419
Alloy 13" Rim & Tyre 175R13LT.	690kgs capacity.	# 1427
Alloy 13" Rim & Tyre 155RLT13	600Kgs capacity.	# 1418
Alloy 13" Rim Only (No Tyre).	750Kgs capacity.	# 1416

14" Black Knight Alloy Rim & Tyres.

Suits: Ford PCD 114mm.

Alloy 14" Rim & Tyre 185/14C	840kgs capacity.	# 1422
Alloy 14" Rim & Tyre 195/R14C	950kgs capacity.	# 1428
Alloy 14" Rim (No Tyre).	1000kgs capacity.	# 1417



Spare Wheel Covers.

Black vinyl and white writing: Suits 13".

1520

Black vinyl and white writing: Suits 14".

1521



Plastic Wheel Chocks.

Light and easy to store in the boot of the car.

Wheel chock sold in pairs.

1524

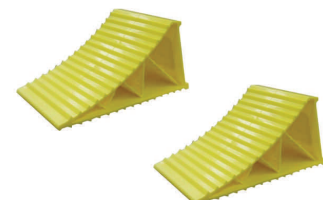

TRAILER EQUIPMENT



Drop Down Spare Wheel Mount

Features:

1. Ideal For Spare Wheel Mounting On Most Drawbars
2. Spare Hub & Bearing Set For your Trailer.
3. Spring Loaded Swing-Up For Traveling
4. Available in 4 Hub & Bearing Models.
5. A Must For Beach Launching

Note: Wheel & Tyre not included

Spare Wheel Mount (Ford LM Bearings)	# 1516
Spare Wheel Mount (Ford Slim Line Bearings)	# 1517
Spare Wheel Mount (HT LM Bearings)	# 1518
Spare Wheel Mount (HT Slim Line Bearings)	# 1519

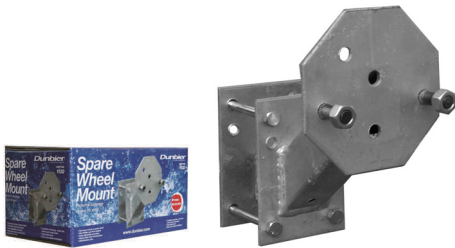

Spare Wheel Carrier.

Suits: Trailer side frames from 75 to 100 deep x 50mm

Suits: 13" or 14" wheels.

Measurement: H150 x W 115mm.

Display packed as shown.

1532



High Mount Spare Wheel Carrier.

Suits: 13", 14" & 15" wheels.

Suits: Side frames 75, 100 & 127 x 50mm.

Measurement: H260 x W 225mm.

Spare wheel carrier.

1531

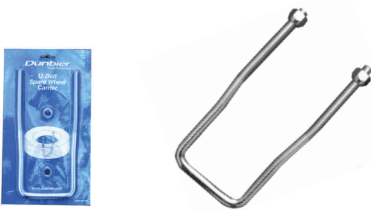

Spare Wheel Carrier.

Suits: 13" and 14" wheels fits 75mm drawbars or winch post.

Display packed as shown.

1525



Bearing Buddy..... The Original.

Bearing Buddy chrome plated and stainless steel components.

Made in USA, packaged and sold in pairs.

Suits 50 & 63mm 2 tonne axles.

1781



Bearing Buddy..... The Original.

Bearing Buddy chrome plated and stainless steel components.

Made in USA, packaged and sold in pairs.

1780



Bearing Protectors.

Bearing Protector chrome plated steel, includes PVC covers.

Made in China, packaged and sold in pairs.

1779



Bearing Protector.

Bearing Protector suits TROJAN 65mm square 2 tonne axles.

Includes covers and sold in pairs.

1778

Bearing Protector Covers.

Bearing Protector PVC covers, suits most bearing protectors.
Made in China, packaged and sold in pairs. # 1782



Galvanized Steel Dust Cover.

Suits all hubs with bearing cup size LM11910.
Sold in Pairs. # 1740



Wheel Nuts 7/16".

Single wheel nut. # 1670
5 Wheel nuts per display pack. # 1660C



Wheel Nuts 1/2".

Single wheel nut. # 1669
5 Wheel nuts per display pack. # 1661C



Wheel Nuts 1/2".

Single: Suits 13,14 & 15" alloy Rims. # 1489



Wheel Hub Stud 7/16".

Single hub stud only. No Nut # 1673
5 Wheel hub studs & Nuts display packed. # 1663C



Wheel Hub Stud 1/2".

Single hub stud. No Nut # 1674
5 Wheel hub studs & Nuts display packed. # 1664C



Axle Zinc Plated Split Pins.

Size: M4 x 25mm, single split pin # 1681
10 split pins per display pack. # 1680



Axle Nut & Axle Washer Bulk.

Single axle nut. # 1671
Work shop bulk, single M20 zinc coated washer. # 8932



Axle Nut, Washer & Split Pin Kit.

Zinc plated finish suits: axles 39mm round to 45mm square.
Display pack with a pair of each as shown. # 1622C



TRAILER EQUIPMENT



Bearing Set & Grease Seal.

Suits all *Dunbier* Trailers with 39mm rd & 40mm sq axles.
 Large Cup LM67010 & Cone LM67048.
 Small Cup LM11910 & Cone LM11949, Seal # 1710
 Work shop bulk, Qty 50 sets. # 1690B
 Display pack. # 1690S



Bearing Set & Two Part Grease Seal.

Suits all *Dunbier* Trailers with 39mm rd & 40mm sq axles.
 Large Cup LM67010 & Cone LM67048
 Small Cup LM11910 & Cone LM11949, Seal # 1715
 Work shop bulk, Qty 50 sets. # 1688B
 Display pack # 1688S



Bearing Set & Grease Seal.

Suits *Dunbier* Trailers with 45 & 50mm sq axles.(Slimline)
 Large Cup L68110 & Cone L68149.
 Small Cup LM12710 & Cone LM12749, Seal #1706.
 Work shop bulk, Qty 50 sets. # 1707B
 Display pack. # 1707S



Bearing Set & Two Part Grease Seal.

Suits *Dunbier* Trailers with 45 & 50mm sq axles.(Slimline)
 Large Cup L68110 & Cone L68149.
 Small Cup LM12710 & Cone LM12749, Seal #1716.
 Display pack. # 1712
 Work Shop Bulk 50 Sets # 1712B



Bearing Set & Two Part Grease Seal 2.2T.

Suits *Dunbier* Trailers with Holroyd 65mm sq tube axle.
 Large Cup 25520 & Cone 25580.
 Small Cup LM67010 & Cone LM67048.
 Seal to suit: # 33940, sold as complete kit. # 1708



Bearing Set & Two Part Grease Seal 2.2T.

Suits *Dunbier* Trailers with Alko 65mm tube square axles.
 Large Cup & Cone # HR30210.
 Small Cup # 15123 & Cone # 15245.
 Two Part Seal # 82140, sold as complete kit. # 1708A



Bearing Set & Two Part Grease Seal 2.2T.

Suits *Dunbier* Trailers with Trojan 65mm tube square axles.
 Cup # LM44649 & LM48548
 Cone # LM4464610 & LM 48510
 Two Part Seal # PT10141, Sold as complete kit. # 1711S



Wheel Hub Standard Grease Seal.

Suits: 39mm round to 40mm square axles.. # 1710
 Suits: 45mm sq axles slimline. # 1706



Wheel Hub Grease Seals.

Suits: Holroyd 50mm axles (Seal Dia OS 86 x IS 47.5) . # 1705



Wheel Hub Two Part Grease Seals.

Single: Suits Trailers with 39 & 40mm axles. # 1715B
 Sold in pairs display Packed. # 1715S
 Single: Suits trailers with 45mm axles. # 1716
 Sold in pairs display Packed. # 1716S
 Single: Suits Holroyd & Meher 50 & 65mm, 2.2 tonne axles. # 1717
 Single: Suits Alko 65mm, 2.2 tonne axles # 1718
 Single: Suits Trojan 65mm 2.2 tonne axles # 1719

Trailer Wheel Bearing Grease.

FUCHS high temperature wheel bearing grease in a tub.
 Suitable for all types of trailers that operate in extreme conditions.
 Sold in tubs 500 grams. # 1831



Trailer Wheel Bearing Grease.

FUCHS high temperature wheel bearing grease in a cartridge.
 Suitable for all types of trailers that operate in extreme conditions.
 Sold in cartridges 450 grams. # 1832



Trailer Wheel Hub In A Tub.

Complete kit in a plastic tub includes, wheel hub, pre-greased bearings, seal, dust cap and wheel nuts.
Hub Kit Suits: Ford with LM series bearings. # 1665
 Ford with Slim Line series bearings. # 1666
 HT Holden with LM series bearings. # 1667
 HT Holden with Slim Line series bearings. # 1668



Wheel Hub With Small Flange 140mm.

Galvanized 1/2" x 5 stud "Ford" Pitch Circle Dia 114mm
 Includes LM bearings, seal and dust cap.
 Suits: Foldaway Trailer from March 2010 # 1652



Wheel Hub With Standard Flange 150mm.

Galvanized 7/16" x 5 stud "Holden" Pitch Circle Dia 108mm
 Includes LM bearings, seal and dust cap.
 Suits: Dunbier and most other brands of Trailers. # 1653



Wheel Hub With Standard Flange 150mm.

Galvanized 1/2" x 5 stud "Ford" Pitch Circle Dia 114mm
 Includes LM bearings, seal and dust cap.
 Suits: Dunbier and most other brands of Trailers. # 1649



Wheel Hub With Standard Flange 150mm.

Galvanized 1/2" x 5 stud "Ford" Pitch Circle Dia 114mm
 Includes Heavy Duty Slimline bearings, seal and dust cap.
 Suits: Dunbier and most other brands of Trailers. # 1649F



Disc Brake Wheel Hub.

Suits: 13 & 14" wheels, hydraulic or Mechanical Calipers
 Galvanized 5 stud "Ford" pattern with LM bearing set, No Seal.
 Suits: All Dunbier Trailers with 40mm square axles. # 1912



Disc Brake Galvanized Wheel Hub.

Suits: 13 & 14" wheels, hydraulic or Mechanical Calipers
 5 stud "Ford" pattern with Slimline bearing set, No Seal. # 1912SL
 5 stud "HT" pattern with Slimline bearing set, No Seal. # 1908SL
 Suits: Most Trailers with 45mm square axles.



TRAILER EQUIPMENT



Disc Brake Wheel Hub.

Suits: 13 & 14" wheels, hydraulic or Mechanical Calipers
Galvanized 5 stud "HT" pattern with LM bearing set, No Seal
Suits: Most Trailers with 40mm square axles.

1908G



Disc Brake Wheel Hub.

Suits: 600 x 9 wheels.
Galvanized 5 stud "HT" with LM BEARING CUPS ONLY.
Suits: Most Trailers with 40mm square axles.

1910G



Disc Brake Wheel Hub 6 Stud.

Galvanized disc 16mm, with Land Cruiser stud pattern.
Includes Bearings and two part seal & dust cap.

Suits: ALKO 65mm square tube axle.

1909

Suits: Holyrod 65mm square tube axle.

1917



Disc Brake 6 Stud Hub & Stainless Rotor 2.2T

Galvanized hub with 275 x 11mm stainless Rotor
Land Cruiser stud pattern.

Includes: Bearings and two part seal & dust cap.

1918



Disc Brake 5 Stud Hub & Stainless Rotor 1.5T

Galvanized hub with 225 x 11mm stainless Rotor
Standard Dunbier 5 stud pattern.

Includes: SL Bearings, two part seal & dust cap.

1919



Disc Brake 6 Stud Hub & Cast Iron Rotor 2.2T

Galvanized hub with 275 x 11mm cast Iron Rotor
Land Cruiser stud pattern.

Includes: Bearings and two part seal & dust cap.

1920



Replacement Disc Brake Rotors Only.

275 x 11mm stainless rotor 2.2Tonne

1921

275 x 11mm cast iron rotor 2.2Tonne

1922

225 x 11mm stainless rotor 1.5Tonne

1931



Hydraulic Trojan Stainless Brake Caliper.

Stainless Steel Caliper: Suits 11mm width rotor.

1923

Stainless Steel Caliper: Suits 15mm width rotor.

1924

Caliper axle mount to suit: 11mm rotor

1958

Caliper axle mount to suit: 15mm rotor

1970



Hydraulic Trojan Cast Iron Brake Caliper.

Cast Iron Caliper: Suits 11mm width rotor.

1926

Cast Iron Caliper: Suits 15mm width rotor.

1925

Caliper axle mount to suit: 11mm rotor

1958

Caliper axle mount to suit: 15mm rotor

1970



Hydraulic Disc Brake Caliper.

Suits: Dunbier hydraulic brake axles Alko & Meher.

Complete as shown with mounting bolts.

1956



Mechanical Disc Brake Caliper.

Suits: All Dunbier mechanical brake axles.

Complete as shown.

1971

39mm Round Stub Axle.

Raw metal finish, 200mm long suits LM Bearing set.
Complete with hex nut and washer.

1630



39mm Round Stub Axle.

Raw metal finish, 250mm long suits LM Bearing set.
Complete with hex nut and washer.

1629



45mm Round Stub Axle.

Raw metal finish, 200mm long, suits Slimline Bearing set.
Complete with hex nut and washer.

1631



Axle Saddle Galvanized.

Suits: 39mm Round Axle.

1621



Square Axle Saddle.

Axle Saddle black metal.
Axle Saddle galvanized.
Axle Saddles Display Packed, sold in pairs.

1620
1620G
1620GC

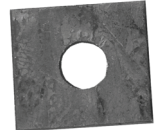

Axle Assembly Suits FOLD-A-Way Trailer.

Replacement assembly including guard as shown.
Replacement guard only.

2231
2232



Mechanical Brake Conversion Kit.

Dunbier has put together a mechanical brake conversion kit that includes every thing you need to convert your trailer to an over-ride mechanical brake system.

Brake kit includes.

- 1 x 10M of Brake Cable.
- 1 x Hand Brake Assembly.
- 2 x Mechanical Disc Calipers.
- 1 x Mechanical Override Coupling.
- 2 x Caliper Mounts including bolts.
- 2 x Galvanized Disc Hubs, LM Bearings and dust caps.

Brake Kit with Ford Discs.

1845G

Brake Kit with HT Holden Discs.

1846G

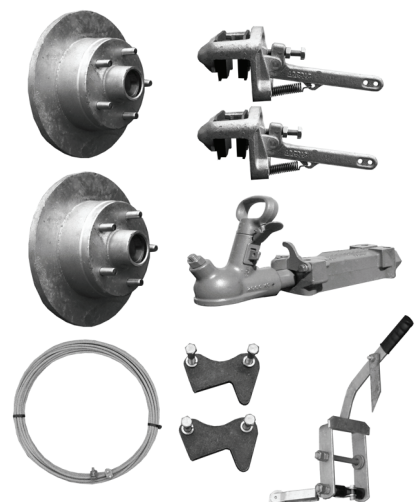

TRAILER EQUIPMENT

Galvanized 39mm Solid Round Axles.

Suits: Bearing Sets. LM67010 & LM11910 / LM67048 & LM11949
 Suits: Seal # 1710



	Wheel Size	O/A Axle Length	Chassis Width	Part #
Axle Bar Only.	13"	1525(60")	1085	# 1535G
Axle Ford hubs & bearings.	13"	1500(59")	1060	# 1536G
Axle Bar Only.	13"	1675(66")	1200	# 1563G
Axle: Ford hubs & bearings.	13"	1675(66")	1200	# 1562G
Axle Bar Only.	10"	1800(71")	1465	# 1550G
Axle: Ford hubs & bearings.	10"	1800(71")	1465	# 1549G
Axle Bar Only.	13"	1920(75.5")	1465	# 1561G
Axle: Ford hubs & bearings.	13"	1920(75.5")	1465	# 1560G
Axle Bar Only.	13"	1980(78")	1525	# 1564G
Axle: Ford hubs & bearings.	13"	1980(78")	1525	# 1564

Galvanized 40mm Solid Square Axles.

Suits: Bearing Sets. LM67010 & LM11910 / LM67048 & LM11949
 Suits: Seal # 1710



	Wheel Size	O/A Axle Length	Chassis Width	Part #
Axle Bar Only.	13/14"	1920(75.5")	1465	# 1571G
Axle: Ford hubs & bearings.	13/14"	1920(75.5")	1465	# 1570G
Axle: Bar Only.	13/14"	1982(78")	1525	# 1572

Galvanized 45mm Solid Square Axles.

Suits: Bearing Sets. L68110 & LM12710 / L68149 & LM12749
 Suits: Seal # 1706



	Wheel Size	O/A Axle Length	Chassis Width	Part #
Axle Bar Only.	13/14"	1920(75.5")	1465	# 1577G
Axle: Ford hubs & bearings.	13/14"	1920(75.5")	1465	# 1576G
Axle Bar Only.	13/14"	2170(85.5")	1725	# 1583G
Axle: Ford hubs & bearings.	13/14"	2170(85.5")	1725	# 1582G
Axle Bar Only.	13/14"	2340(92")	1860	# 1589G
Axle: Ford hubs & bearings.	13/14"	2340(92")	1860	# 1588G

Mechanical & Hydraulic 40mm Sq Disc Brake Axles.

Suits: Bearing Sets. LM67010 & LM11910 / LM67048 & LM11949Seal # 1710

	Wheel Size	O/A Axle Length	Chassis Width	Part #
Mechanical: Ford Disc Axle.	13/14"	1920(75.5")	1465	# 1603G
Hydraulic: Ford Disc Axle.	13/14	1920(75.5")	1465	# 1602G



Galvanized 45mm Over- Lay Square Axles.

Suits: Bearing Sets. L68110 & LM12710 / L68149 & LM12749
Suits: Seal # 1706

	Wheel Size	O/A Axle Length	Chassis Width	Part #
Axle: Bar Only Overlay	13/14"	2190(86")	1750	# 1568G
Axle: Lazy hubs & bearings.	13/14"	2190(86")	1750	# 1569G
Axle: Mech Disc Brake	13/14"	2190(86")	1750	# 1592
Axle: Bar Only.	13/14"	2340(92")	1860	# 1605
Axle: Lazy hubs & bearings.	13/14"	2340(92")	1860	# 1600G
Axle: Mech Disc Brake	13/14"	2340(92")	1860	# 1604
Axle: Hyd Disc Brake	13/14"	2340(92")	1860	# 1604H



Mechanical & Hydraulic 45mm Sq Disc Brake Axles.

Suits: Bearing Sets. L68110 & LM12710 / L68149 & LM12749.....Seal # 1706

	Wheel Size	O/A Axle Length	Chassis Width	Part #
Mechanical Disc Axe	13/14"	2340(92")	1860	# 1590G
Mechanical Disc Axle.	13/14"	1920(75.5")	1465	# 1607G
Hydraulic : Ford Disc Axle.	13/14	1920(75.5")	1465	# 1606G
Mechanical: Ford Disc Axle.	13/14"	2170(85.5")	1725	# 1609G
Hydraulic: Ford Disc Axle.	13/14	2170(85.5")	1725	# 1608G



Mechanical & Hydraulic 50mm Sq Disc Axles.

Bearing Set: L68110/LM12710 & L68149/LM12749,Seal: # 1706

	Wheel Size	O/A Axle Length	Chassis Width	Part #
Mechanical: Ford Disc Axle.	13/14"	1920(75.5")	1465	# 1615
Hydraulic: Ford Disc Axle.	13/14	1920(75.5")	1465	# 1614
Axle Bar Only.	13/14	1920(75.5")	1465	# 1612G
Mechanical: Ford Disc Axle.	13/14"	2170(85.5")	1725	# 1617
Hydraulic: Ford Disc Axle.	13/14	2170(85.5")	1725	# 1616
Axle Bar Only.	13/14	2170(85.5")	1725	# 1613G



TRAILER EQUIPMENT

Hydraulic 65mm Sq ,6 Stud Disc Axle 2.2 Tonne.

Alko: Bearing Set: HR30210/15123 & 15245, Seal: # 182140
 Holroyd: Bearing Set: 25520/25580 & LM67010/LM67048, Seal: # 821230
 Trojan: Bearing Set: LM44649/LM4464610 & LM48548/LM48510, Seal: # 1711

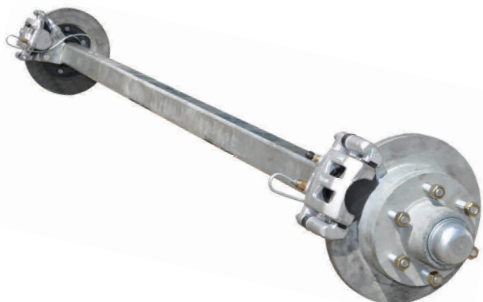

	Wheel Size	O/A Axle Length	Chassis Width	Part #
ALKO: L/Cruiser Hydraulic Disc Axle.	15"	2275(89.5")	1720	# 1618
ALKO Axle Bar Only.	15"	2275(89.5")	1720	# 1619
HOLROYD: L/Cruiser Hydraulic Axle.	14/15"	2275(89.5")	1720	# 1618H
HOLROYD Axle Bar Only.	14/15"	2275(89.5")	1720	# 1619H
TROJAN :L/Cruiser Hyd Disc Axle	14/15"	2275(89.5)	1720	# 1618T
TROJAN: Axle Bar Only	14/15"	2275(89.5)	1720	# 1632

Gull Wing Duratorque Axles.

Bearing Set: 2200Kgs LM44649/LM4464610 & LM48548/LM48510, Seal: # 1711
 Bearing Set: 1750kgs L68110/LM12710 & L68149/LM12749, Seal: # 1706

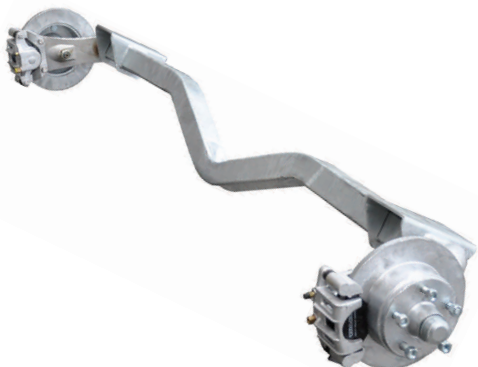

	Wheel Size	O/A Axle Length	Chassis Width	Part #
Duratorque Axle 750kg No Hubs	14"	2300(90.5")	1200	# 1574
Duratorque Axle 750kg with Hubs	14"	2300(90.5")	1200	# 1575
Duratorque Axle 2200Kgs No Hubs	14/15"	2300(90.5")	1720	# 1578
Duratorque Disc Brake Axle 2200Kgs	14/15"	2300(90.5")	1720	# 1578G
Duratorque Axle 1750Kgs No Hubs	14"	2300(90.5")	1720	# 1579
Duratorque Disc Brake Axle 1750Kgs	14"	2300(90.5")	1720	# 1579G
Duratorque No Brake Axle 1750Kgs	14"	2300(90.5")	1720	# 1583

Galvanized 50mm Overlay Square Axle

Suits Bearing Sets:
 Suits Seal:



	O/A Axle Length	Part #
Overlay Mech Brake 50mm Axle	2170(85.5")	# 1592
Overlay Hyd Brake 50mm Axle	2170(85.5")	#1593
Overlay Bar Only 50mm Axle	2170(85.5")	#1594
Overlay Mech Brake 50mm Axle	1920(75.5")	#1595
Overlay Hyd Brake 50mm Axle	1920(75.5")	# 1596
Overlay Bar Only 50mm Axle	1920(75.5")	# 1597
Overlay Mech Disc 50mm Axle	2390(94")	# 1598
Overlay Hyd Disc 50mm Axle	2390(94")	# 1599
Overlay Lazy 50mm Axle	2390(94")	# 1600

Please Note: Australian Design Rules requires capacities for independent suspension over two axles Less 20%

Flexible Braided Stainless Steel Brake Lines



Length	Part #
500mm	# 1893
650mm	# 1894
750mm	# 1895
1000mm	# 1896
1750mm	# 1897
2000mm	# 1898
6500mm	# 1901

Stainless steel flexible braided brake lines with brass end fittings no flaring required outlasts conventional steel brake tubing. Matches original brake line fittings on most trailer.

Four Wheel Stainless Steel Brake Line Kit

The diagram illustrates a four-wheel stainless steel brake line kit. It includes an actuator (6500mm #1901) connected to a central manifold (#1860). From this manifold, two lines (1000mm #1896) lead to the front brake callipers, and two lines (1750mm #1897) lead to the rear brake callipers. A box of Dunbrier brake lines is shown for reference.

Brake Kit # 1886
 Components
 1 x # 1901
 3 x # 1896
 2 x # 1897
 1 x # 1893
 3 x # 1860

Two Wheel Stainless Steel Brake Line Kit

The diagram illustrates a two-wheel stainless steel brake line kit. It includes an actuator (6500mm #1901) connected to a central manifold (#1860). From this manifold, one line (1000mm #1896) leads to the front brake calliper, and one line (1750mm #1897) leads to the rear brake calliper. A box of Dunbrier brake lines is shown for reference.

Brake Kit # 1887
 Components
 1 x # 1901
 1 x # 1896
 1 x # 1897
 1 x # 1860

EASY INSTALLED	
Four wheel brake Kit to 8M	# 1886
Two Wheel Brake Kit to 5.8M	# 1887

TRAILER EQUIPMENT



NEW

Mechanical Disc Brake Caliper Pads

Mechanical 2 Bolt Type. Alko & Meher Calipers.
Suits: Most trailers on the market today.
Sold in pairs. Used on trailers from January 2018.

1933



Stainless Steel Mechanical Disc Brake Pads.

Suits: Most trailers on the market today.
Sold in sets of 4

1928



Stainless Steel Hydraulic Disc Brake Pads.

Suits: Alko and Meher hydraulic calipers.
Sold in sets of 4

1930



Mechanical Disc Brake Caliper Pads.

Suits: Most trailers on the market today.
Sold in sets of 4

1927



Hydraulic Disc Brake Caliper Pads.

Suits: Alko and Meher hydraulic calipers.
Sold in sets of 4

1929



Hydraulic Caliper Piston.

Suits: Alko and Meher hydraulic calipers # 1956.
Complete as shown.

1953



Hydraulic O Ring & Boot Set.

Suits: Alko and Meher hydraulic calipers # 1956.
Complete as shown.

1954



Hydraulic Slide Pin Kit.

Suits: Alko and Meher hydraulic calipers # 1956.
Complete as shown.

1955



Hydraulic Disc Brake Caliper Mount.

Suits: Dunbier hydraulic axles.
Complete as shown.

1958



Mechanical Disc Brake Caliper Mount.

Suits: Dunbier mechanical axles.
Complete as shown.

1970



Mechanical Brake Caliper Slider.

Stainless steel and suits all mechanical calipers.
Sold in Pairs

1969

1969P



Hydraulic Brake Flexible Hose.

Suits: All hydraulic 3/16" brass brake fittings.

1850



Plastic Coated Steel With Brass Fittings, Brake Lines.

Length: 460mm , suits 3/16" fittings. # 1890
Length: 560mm , suits 3.16" fittings. # 1891
Length: 1420mm, suits all 3/16" fittings. # 1892
Length: 1780mm, suits all 3/16" fittings. # 1900

TRAILER EQUIPMENT

Hydrastar Front Brake Line Union.

Replacement union including gasket.

7206



Hydraulic Brake Line Joiner.

Brass material, suits 3/16" brake lines.

1870

3 Way Tee. Brass material, suits 3/16" brake lines.

1860

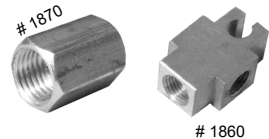

Hydraulic Brake Line Connector.

Suits: Hydraulic master cylinder & Hydraulic calipers.

1880

Copper washer sold separately.

1881

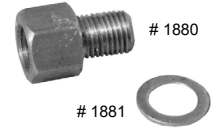

Hydraulic Brake Coupling Master Cylinder.

Hydraulic master cylinder.

1840

Hydraulic master cylinder replacement plastic cap.

1841



Mechanical Disc Brake Caliper Spring.

Replacement stainless steel spring.

Complete as shown. Sold in pairs

1977



Mechanical Caliper Spring & Bolt

Replacement stainless steel spring.

1979

Complete as show. Wishbone type.

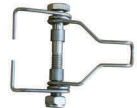

Mechanical Brake Cable.

Galvanized and PVC coated. Sold by the meter.

1974



Mechanical Brake Cable Adjuster & Pulley.

Galvanized and complete as shown.

1972



Mechanical Brake Cable Kit.

Includes:

Cable adjuster, 8M PVC coated cable and two clamps.

Galvanized and complete as shown.

1845



Mechanical Brake Cable Clamp.

Bulk: Galvanized as shown.

1973

Display pack with 2 as shown.

1976



Mechanical Brake Handbrake Assembly.

Suits: 76mm square tube, complete as shown.

1090

Suits: 100mm square tube, complete as shown.

1093

Suits: 130mm square tube, complete as shown.

1094

Suits: 150mm square tube, complete as shown.

1096



Hydrastar Plastic Cap.

Replacement cap.

7201



Hydrastar Detector Board.

Replacement detector board.

7207



Hydrastar Electric Motor.

Replacement motor, post 2005.

7204



TRAILER EQUIPMENT



7202A



7202B

Hydrastar Coil Solenoid Assembly.

Hydrastar Solenoid Coil Assembly
Hydrastar Solenoid Valve

7202A
7202B



Hydrastar Gasket Set.

Replacement gasket set.

7200



Hydrastar 1200 PSI Braking System.

Standard braking system on Dunbier trailers over 2 tonne.
Complete with battery pack and breakaway switch.

1938



Hydrastar 1200 PSI Braking System.

Standard braking system on Dunbier trailers over 2 tonne.
Unassembled, no battery pack or breakaway switch.

1943



Hydrastar Battery Pack.

Includes battery and breakaway switch as shown.
Replacement Battery Box only.

1944
7209



Hydrastar 1200 PSI Assembled Braking System.

Standard braking system on Dunbier trailers over 2 tonne.
Assembled, complete with battery pack and breakaway switch.
Complete with trailer mounting bracket as shown.

1939



Hydrastar Breakaway Switch.

Replacement switch as shown.

7205



Hydrastar Mounting Bracket.

Galvanized and ready to mount the Hydrastar.

1940



Hydrastar Power Cable.

Replacement Power cable between vehicle & trailer.

1941



BRAKE CONTROLLER: PREDATOR DX2.

In vehicle electronic brake controller for single or tandem axle.
Digital LED displays voltage output assists with level set-up.
Displayed pack, designed to work with Hydrastar braking.

1945



BRAKE CONTROLLER: TEKONSHA PRODIGY P2.

In vehicle electronic brake controller for 1-4 axles.
Digital display depicts voltage delivery during braking.
Displayed pack, designed to work with Hydrastar braking.

1950

TRAILER EQUIPMENT

Display Boxed, Dacromet Coated Slipper Spring Kits.

Includes: 2 x Springs, 4 x Ubolts, 2 x Fish Plates & 2 x Shackle Bolts.

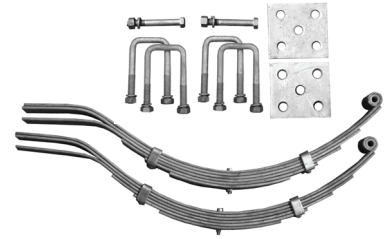

Part #	Spring Kit Description	Ubolt Set	Load Per Kit
2014K	3 Leaf x 45 wide Slipper Spring Kit	Round	800Kgs
2019K	4 Leaf x 45 wide Slipper Spring Kit	Square	1100Kgs
2015K	5 Leaf x 45 wide Slipper Spring Kit	Square	1200Kgs
2016K	6 Leaf x 45 wide Slipper Spring Kit	Square	1400Kgs
2017K	7 Leaf x 45 wide Slipper Spring Kit	Square	1500Kgs
2018K	9 Leaf x 45 wide Slipper Spring Kit	Square	1800Kgs

Dacromet Coated Slipper Springs.

Part #	Spring Description	Load Per Spring
2014	3 Leaf x 45 wide Slipper Spring.	400Kgs
2019	4 Leaf x 45 wide Slipper Spring.	550Kgs
2015	5 Leaf x 45 wide Slipper Spring.	600Kgs
2016	6 Leaf x 45 wide Slipper Spring.	700Kgs
2017	7 Leaf x 45 wide Slipper Spring.	750Kgs
2018	9 Leaf x 45 wide Slipper Spring.	900Kgs
2021	10 Leaf x 45 wide Slipper Spring.	1000Kgs

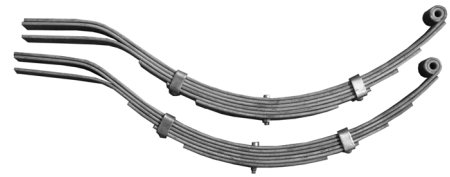

Dacromet Coated Load Share Springs. All Includes Hardware

Part #	Spring Set Description	Load Per Set
2008	Springs W60mm x 9 Leaf suits: 15" Wheel	4400Kgs
2012	Springs W60mm x 7 Leaf suits: 13 & 14" Wheel	3500Kgs

Load Share Spring Set

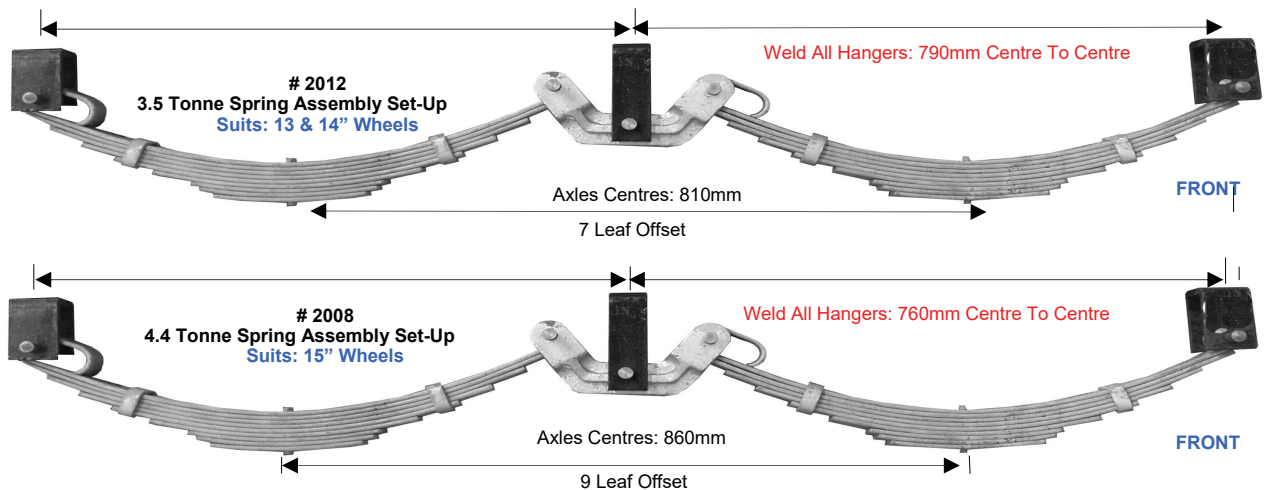

Slipper Spring Shackle Bolt.

Galvanized shackle bolt, suits 45mm slipper spring.
Display packed & sold in pairs.

2070C



Slipper Spring Shackle Bush.

Nylon shackle bush, suits 45mm slipper spring.
Display packed & sold in pairs.

2060C

TRAILER EQUIPMENT



Fish Plates Galvanized.

Suits 45mm wide springs & 42mm wide ubolt (Bulk). # 2020
 Suits 60mm L/Share spring & 45 to 52mm wide ubolts (Bulk). # 2022
 Suits 60mm wide L/Share spring & 65mm wide ubolt (Bulk). # 2023



Standard Front Spring Hanger.

Suits: 45mm wide spring, raw metal finish. # 2030
 Suits: 45mm wide spring, galvanized finish. # 2030G
 Suits: 45mm wide spring, galvanized & sold in pairs. # 2030GS



Deep Front Spring Hanger.

Suits: 45mm wide spring, raw metal finish. # 2040
 Suits: 45mm wide spring, galvanized finish. # 2040G
 Suits: 45mm wide spring, galvanized & sold in pairs. # 2040GS



Rear Spring Hanger.

Suits: 45mm wide spring, raw metal finish. # 2050
 Suits: 45mm wide spring, galvanized finish. # 2050G
 Suits: 45mm wide spring, galvanized & sold in pairs. # 2050GS

Galvanized Ubolts Complete With Nuts & Washers.

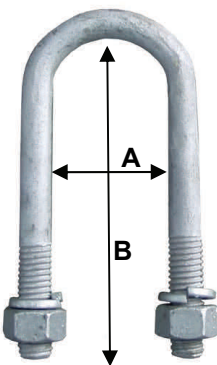
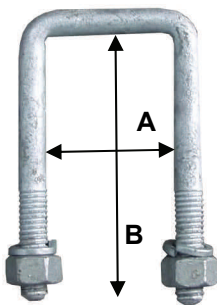

Bulk #	Sold	D/Packed #	Sold	Description	Round	Square	A	B
# 2100B	S	# 2100S	PR	42 x 115 x 12	√		42	115
# 2110B	S	# 2110S	PR	67 x 90 x 12	√		67	90
# 2120B	S	# 2120S	PR	77 x 110 x 12	√		77	110
# 2121	S			67 x 60 x 12	√		67	60
# 2130B	S	# 2130S	PR	52 x 80 x 12	√		52	80
# 2150B	S	# 2150S	PR	52 x 110 x 12	√		52	110
# 2160B	S	# 2160S	PR	52 x 145 x 12	√		52	145
# 2170B	S	# 2170S	PR	52 x 165 x 12	√		52	165
# 2191B	S	# 2191S	PR	24 x 60 x 10	√		24	60
# 2192	S			152 x 140 x 12	√		152	140
# 2193	S			102 x 195 x 12	√		102	180
# 2194	S			77 x 210 x 12	√		77	190
# 2195	S			67 x 180 x 16	√		67	180
# 2196	S			22 x 95 x 10	√		22	95
# 2197	S			41 x 45 x 10	√		41	45
#2199	S			77 x 160 x 12	√		77	160
# 2210B	S	# 2210S	PR	44 x 100 x 12	√		44	100
# 2212B	S	# 2212S	PR	77 x 80 x 12	√		77	80
# 2213	S			47 x 140 x 12	√		47	140
# 2214	S			102 x 140 x 12	√		102	140
# 2216	S			127 x 160 x 12	√		127	160

S- Single
PR- Pair



Mudflaps: Suits Plastic Mudguards.

Part #	Wheel Size	Colour	Description
# 2225	13" & 14"	White	Dunbier, sold in pairs.
# 2225G	13" & 14"	Grey	Dunbier, sold in pairs.
# 2225B	13" & 14"	Black	Dunbier, sold in pairs.

Plastic Mudguards, Include Mudflaps.

Part #	Wheel	Colour	Carrier To Suit
# 2380	13"	White (Wasson)	# 2350R & # 2350L
# 2380G	13"	Grey (Wasson)	# 2350R & # 2350L
# 2380B	13"	Black (Wasson)	# 2350R & # 2350L
# 2390	14"	White (Wasson)	# 2360R & # 2360L
# 2390G	14"	Grey (Wasson)	# 2360R & # 2360L
# 2390B	14"	Black (Wasson)	# 2360R & # 2360L

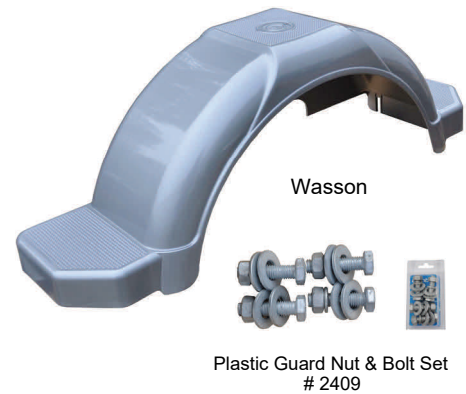

Rolled Alloy Propeller Plate Mudguards.

Part #	Wheel Size	Description
# 2260	13"&14"	Tandem : L1605 x H380 x W230
# 2257	14"	Single: L820 x H380 x W230
# 2256	13"	Single: L760 x H380 x W230

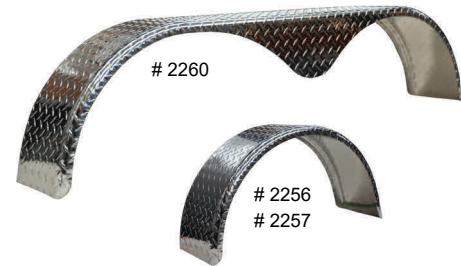

Jeep Style Mudguards.

Part #	Wheel Size	Description
# 2230	10"	Raw metal finish.
# 2232	8"	Galvanized & drilled: suits foldaway trailer.
# 2239	8"	Raw metal finish.
# 2240	9",13" & 14"	Raw metal finish.
# 2238	15" & 16"	Raw metal finish



Galvanized Carriers To Suit Plastic Mudguards

Part #	Wheel Size	Description
# 2350R	13"	Single axle mudguard carrier R.H.
# 2350L	13"	Single axle mudguard carrier L.H.
# 2360R	14"	Single axle mudguard carrier R.H.
# 2360L	14"	Single axle mudguard carrier L.H.



TRAILER EQUIPMENT

Galvanized Spring Carriers To Suit Plastic Mudguards.



Part #	Wheel	Description
# 2361	13"	Tandem slipper spring mudguard carrier R.H.
# 2362	13"	Tandem slipper spring mudguard carrier L.H.
# 2363	14"	Tandem slipper spring mudguard carrier R.H.
# 2364	14"	Tandem slipper spring mudguard carrier L.H.



2351



2355

2357



2359R

Spring Carriers To Suit Alloy Mudguards.

Part #	Wheel	Description
# 2351	13"	Single slipper spring guard carrier, Steel Steps RH
# 2352	13"	Single slipper spring guard carrier, Steel Steps LH
# 2353	14"	Single slipper spring guard carrier, Steel Steps RH
# 2354	14"	Single slipper spring guard carrier, Steel Steps LH
# 2355	13"	Tandem slipper spring guard carrier, Steel Steps RH
# 2356	13"	Tandem slipper spring guard carrier, Steel Steps LH
# 2357	14"	Tandem slipper spring guard carrier, Steel Steps RH
# 2358	14"	Tandem slipper spring guard carrier, Steel Steps LH
# 2359R	14"	Tandem rocker spring guard carrier, Steel Steps RH
# 2359L	14"	Tandem rocker spring guard carrier, Steel Steps LH

Guard Carriers Suit: **DUNBIER** Alloy and Steel Frame Trailers

Supa-Rolla
8025 & # 8026



8035 to # 8050



8031 to # 8033

NEW



8066 Walkway
Mount kit

Galvanized Trailer Walkways.

Part #	Description
# 8025	Straight walkway: Suits Dunbier SupaRolla Series, 4.7M-5.0M Including: 1x # 8066 mount kit & 2 x 2130B front mounting bolts
# 8026	Straight walkway: Suits Dunbier SupaRolla Series, 5.3M-6.2M Including: 1x # 8066 mount kit & 2 x 2130B front mounting bolts
# 8031 NEW	Gal walkway: 5.3m front 1155mm suits: Sports/ Centreline Series
# 8032 NEW	Gal walkway: 5.0m front 1205mm suits: Sports/ Centreline Series
# 8033 NEW	Gal walkway: 4.7m front 1215mm suits: Sports/ Centreline Series
# 8035	Straight walkway: Suits Dunbier Sports Series, 4.2M to 4.7M, Loader & Rollamatic Series 5M (# 1) Including: 1x # 8066 mount kit & 1 x 2150B front mounting bolt
# 8040	Straight walkway: Suits Dunbier Sports & Centreline Series 4.4M- 4.7M & 5.3M Loader & Rollamatic Series (# 2) Including: 1x # 8066 mount kit & 1 x 2150B front mounting bolt
# 8045	Straight walkway: Suits Dunbier 5M Centreline, 5.7 & 6.2 Loader & Rollamatic Series (# 3) Including: 2x # 8066 mount kit & 1 x 2160B front mounting bolt
# 8050	Straight walkway: Suits Dunbier 5.3M Centreline, 6.5 Loader & Rollamatic Series (# 4) Including: 2x # 8066 mount kit & 1 x 2160B front mounting bolt
# 8066	Walkway Mounting Kit.



Mount Bkt
9731













3044 Shown

Galvanized Roller Rail Assembly's.

Part #	Rail Length	Roller Qty	Size	Material
# 3044	2700	10	8"	Hard Poly Rollers

Full range of roller rail lengths is available refer to current price list

TRAILER EQUIPMENT

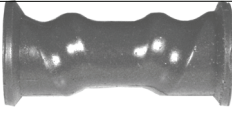
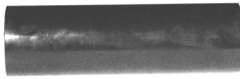
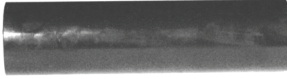
<p>Black Poly Bow Rollers With 12mm Shaft & End Caps. Standard on most Dunbier Trailers, complete with 12mm Suits: 75mm Winch Carrier. # 2892 Suits: 100mm Winch Carrier. # 2893</p>	
<p>Yellow Poly Bow Rollers With 12mm Shaft & End Caps. Standard on most Dunbier Trailers Suits: 75mm Winch Carrier. # 2886 Suits: 100mm Winch Carrier. # 2887</p>	
<p>Poly Bow V Block. Width Base 120. Width Vee 210. # 2979 Depth 70mm x Height 110mm.</p>	
<p>Poly Bow V Block. Width Base 100. Width Vee 115. # 2977 Height 100 x Depth 55mm.</p>	
<p>Rubber Bow V Block. Width 100mm x Depth 50mm x High 80mm. # 2898</p>	
<p>Grey Plastic Wobble Roller. Standard on DUNBIER trailers. Dia: H110 x W75 x Hole 22mm. # 2969</p>	
<p>Grey Rubber Wobble Roller. Dia: H110 x W90 x Hole 22mm. # 2970</p>	
<p>Yellow Large Plastic Wobble Roller. Suits: DUNBIER Alloy Series Trailers. Dia: H127 x W75 x Hole 31mm. # 2968</p>	
<p>Large Wobble Roller Retaining Clips & Washers. Retaining clips & washers, suits Alloy wobble roller arm # 2967 On DUNBIER Alloy Series Trailers. # 2969D</p>	
<p>Wobble Roller Split Pins. Size: M5 x 32mm galvanized finish, single split pin. # 1677 10 split pins per display pack. Not suitable for # 2968 # 1678</p>	
<p>Wobble Roller Washers & Split Pins. Size: M5 x 32mm galvanized finish. Display pack with 10 pair of each. Not suitable for # 2968 # 1679</p>	
<p>Self Centering Rubber Keel Roller 6". Lth 153 x Dia 63mm. # 2975 <i>Shaft to suit: 200 x 16mm Display packed # 3000S</i> <input type="checkbox"/> <i>Bulk # 3000B</i></p>	
<p>Rubber Parallel Roller 6". Lth 145 x Dia 60mm. # 2901 <i>Shaft to suit: 200 x 16mm Display packed # 3000S</i> <input type="checkbox"/> <i>Bulk # 3000B</i></p>	
<p>Rubber Parallel Roller 8". Lth 200 x Dia 60mm. # 2902 <i>Shaft to suit: 245 x 20mm Display packed # 3020S</i> <input type="checkbox"/> <i>Bulk # 3020B</i></p>	

TRAILER EQUIPMENT

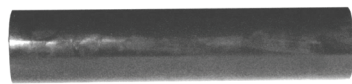

Rubber Parallel Roller 12".

Lth 295 x Dia 60mm.

Shaft to suit: 360 x 24.5mm Bulk

2903
3040



Hard Poly Parallel Roller 10".

Lth 252 x Dia 55mm.

Shaft to suit: 300 x 20mm Bulk

2932
3021



Rubber Dog Bone Keel Roller 12".

Lth 305 x 65 x 95mm.

Shaft to suit: 360 x 24.5mm Bulk

2961
3040



Soft Poly Cotton Reel Keel Roller 8".

Lth 200 x 50 x 70mm.

Shaft to suit: 245 x 20mm Display packed
Bulk

2925
3020S
3020B



Rubber Cotton Reel Keel Roller 8".

Lth 200 x 50 x 70mm.

Shaft to suit: 245 x 20mm Display packed
Bulk

2960
3020S
3020B



Hard Poly Dog Bone Keel Roller 8".

Lth 200 x 45 x 70mm.

Shaft to suit: 245 x 20mm

Blue

Grey

Display packed

Bulk

2908D
2908G
3020S
3020B



Soft Poly Cotton Reel Keel Roller 6".

Lth 155 x 50 x 75mm.

Shaft to suit: 200 x 20mm Display packed
Bulk

2924
3001S
3001B

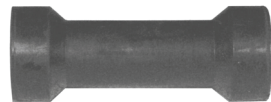

Rubber Cotton Reel Keel Roller 6".

Lth 155 x 50 x 73mm.

Shaft to suit: 200 x 20mm Display packed
Bulk

2909
3001S
3001B

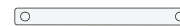

Rubber Dog Bone Keel Roller 6".

Lth 155 x 45 x 60mm.

Shaft to suit: 200 x 16mm Display packed.

2950
3000S



Soft Poly Dog Bone Keel Roller 6".

Lth 155 x 45 x 60mm.

Shaft to suit: 200 x 16mm Display packed

2899
3000S.



Hard Poly Dog Bone Keel Roller 6".

Lth 155 x 45 x 60mm.

Shaft to suit: 200 x 16mm Display packed

Blue
Grey

2897
2897G
3000S.



Rubber Cotton Reel Keel Roller 4.5".

Lth 115 x 55 x 70mm.

Shaft to suit: 160 x 16mm Display packed

2920
2990S



Soft Poly Cotton Reel Keel Roller 4.5".

Lth 115 x 55 x 70mm.

Shaft to suit: 160 x 16mm Display packed

2923
2990S



TRAILER EQUIPMENT

Hard Poly Cotton Reel Keel Roller 4.5"

Lth 115 x 55 x 70mm.

Shaft to suit: 160 x 16mm *Display packed*
Bulk



2895
2990S
2990B



Rubber Keel Roller 4"

Lth 100 x 45 x 60mm.

Shaft to suit: 160 x 16mm *Display packed*
Bulk



2908
2990S
2990B



Rubber Keel Roller 3"

Lth 75 x 35 x 62mm.

Shaft to suit: 120 x 16mm *Display packed*



2907
2981S



KNOTT PVC Roller 12"

Comes with Alloy Sleeve.

2962



Galvanized Roller Brackets.

Roller Bracket suits: 4.5" roller

Roller Bracket suits: 6" roller

Roller Bracket suits: 8" roller

Roller Bracket suits: 12" roller

3235
3236
3237
3238



Single Roller & Bracket 4.5".

Rubber roller.

Hard poly roller.

Soft Poly roller.

3232
3234
3233



Single Roller & Bracket 6".

Rubber roller & Bracket 180mm legs.

Hard poly roller & bracket..

Soft Poly roller & bracket.

3140
3152
3152S



Double Roller & Bracket 6".

Rubber roller & Bracket 180mm legs

Hard poly roller & Bracket 180mm legs

Soft Poly roller & Bracket 180mm legs

3142
3153
3153S



Triple Roller & Bracket 6".

Rubber roller.

Hard poly roller.

Soft Poly roller.

3154
3151
3151S



Single Roller & Bracket 8".

Rubber roller & bracket.

Hard poly roller & bracket.

Soft Poly roller & bracket.

3145
3156H
3156



Double Roller & Bracket 8".

Rubber roller.

Hard poly roller.

Soft poly roller.

3146
3157H
3157



Single Roller & Bracket 10".

Complete with hard poly roller.

3231



Single Roller & Galvanized Bracket 12".

Rubber roller.

Roller bracket only.

3240
3239



TRAILER EQUIPMENT



Double Roller & Galvanized Bracket 12".

Rubber roller.
Roller bracket only.

3230
3229



Double Rolla-Matic.

Galvanized with grey wobble rollers & 20mm square leg.

3100SQ



Double Rolla-Matic.

Galvanized with grey wobble rollers & 40mm square leg.

3100



Double Rolla-Matic No Leg.

Galvanized with grey wobble rollers as shown.

3102



Quad Rolla-Matic.

Galvanized with grey wobble rollers & 40mm square leg.

3110

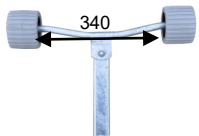

Wide Double Rolla-Matic.

Galvanized with grey wobble rollers & 40mm square leg.

3103

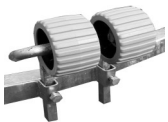

Keel Roller Guide Assembly.

Replace existing keel roller brackets with this assembly.
Galvanized with grey wobble rollers & 20mm square leg.

3106



3337

3336

Single Supa-Rolla Assembly.

Adjustable to suit most boat hulls.

Complete as shown with wobble rollers & 40mm square leg.
Leg, universal bracket and ubolts only. (No Roller Arms).

3336
3337



Roller Assembly Kit, Single Water Vehicle Trailers.

Replace existing pad system with this kit.

Complete as shown with wobble rollers & brackets to suit.

3135

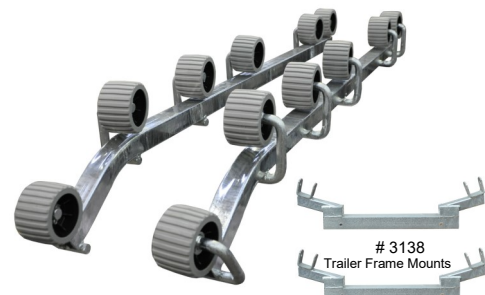

Roller Assembly, Double Water Vehicle Trailers.

Replace existing pad system (sold in pairs)

Same as above, each roller assembly adjust in & out 40mm

Optional frame mounting system with hardware if required
to suit the roller system (sold in pairs)

3135D

3135AD

3138

3138
Trailer Frame Mounts



3M Long Roller Assembly Kit.

Galvanized 50mm square tube with wobble rollers.

Sold in pairs and complete as shown.

3136

Single Supa-Rolla Arms.

300mm long complete with grey roller.
235mm long complete with grey roller.

3260
3260S



Single Supa-Rolla Assembly.

Fully adjustable arms and ready to mount.
Galvanized with grey wobble rollers, bubble plate & ubolts.

3261



Rear 8 Supa-Rolla Assembly.

Complete as shown, extra roller arms to suit heavy boats.
Mounting brackets and ubolts fit 50mm width cross member.

3330

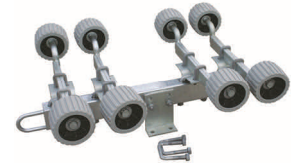

Rear 4 Supa-Rolla Assembly.

Complete as shown, suits Dunbier and most other trailers.
Mounting brackets and ubolts fit 50mm width cross member.

3331

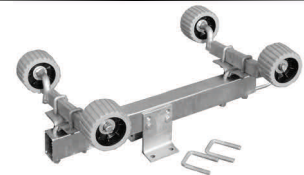

Centre 4 Supa-Rolla Assembly.

Suits Dunbier and most other trailers.
Includes mounting leg, complete as shown.

3332

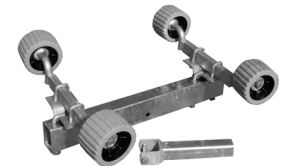

Alloy Single Supa Rolla Arm & Roller

Alloy Arm L300 x H27xW19
Includes large yellow roller H127 x W75x 31mm Hole Dia.

2967



Alloy Single Supa-Rolla Assembly.

Fully adjustable arms and ready to mount.
Large wobble rollers, galvanized bubble plate & ubolts.

3334



Alloy Centre 4 Supa-Rolla Assembly.

Suits Dunbier and most other trailers with alloy arms,
galvanized parallel member, bubble plate and ubolts
Includes mounting leg, complete as shown.

3335

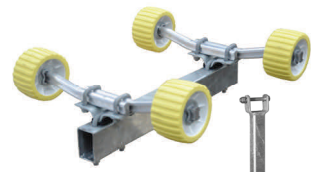

Alloy Rear 4 Supa-Rolla Assembly.

Suits Dunbier and most other trailers with alloy arms,
Includes galvanized parallel member, bubble plate, ubolts
mounting bracket to suit 50mm wide cross member,

3338

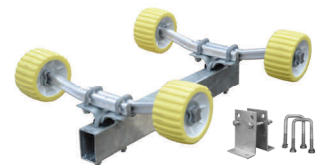

Alloy Rear 6 Supa-Rolla Assembly.

Suits Dunbier and most other trailers with alloy arms,
Includes galvanized parallel member, bubble plate, ubolts
mounting bracket to suit 50mm wide cross member,

3339

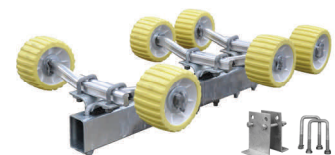

Alloy Rear 8 Supa-Rolla Assembly.

Suits Dunbier and most other trailers with alloy arms,
Includes galvanized parallel member, bubble plate, ubolts
mounting bracket to suit 50mm wide cross member,

3340

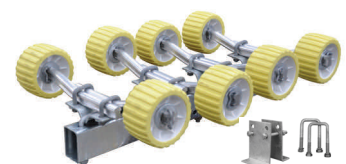

TRAILER EQUIPMENT



Alloy Single Supa-Rolla Assembly.

Adjustable to suit most boat hulls.

Complete with 127mm large wobble rollers, light weight alloy arms and 40mm square leg.

3342

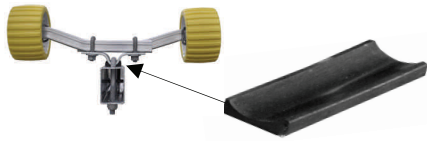

Supa-Rolla Bubble Plate Rubber.

Sold by the meter.

3060



Supa-Rolla Centre Parallel Member.

Suits: Supa-Rolla arm assembly x 2 sets # 3261.

Size: 75 x 50 x Length 600mm.

3293



Supa-Rolla Rear Parallel Member.

Suits: Supa-Rolla arm assembly x 2 sets # 3261.

Size: 75 x 50 x Length 700mm.

3294



Supa-Rolla Rear Parallel Member.

Suits: Supa-Rolla arm assembly x 4 sets # 3261.

Size: 75 x 50 x Length 700mm.

3295



Supa-Rolla Rear Parallel Member.

Suits: Supa-Rolla arm assembly x 4 sets # 3261.

Size: 75 x 50 x Length 900mm.

3297

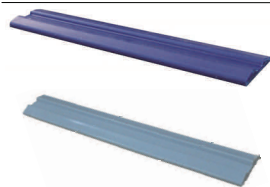

Plastic Trailer Pad Strip

Blue strip 45mm x 10mm and sold in 3.2M lengths

Blue strip 45mm x 10mm and sold in 1.6M lengths

Blue Grey

3053

3053G

3054

3054G



Supa-Rolla Bumper Block.

Suits Dunbier Supa-Rolla arms. Internal size: W45xH48.

Grey plastic and sold in 1.5M lengths.

2891B



Bumper Block.

Suitable for fitting over 50sq steel tube for trailer pads.

Internal size: W55xH50, Blue plastic and sold in 1.5M lengths.

2890 **BLUE**

2890G **GREY**



Plastic Trailer Pads.

300mm length. Grey.

3346



NEW

Bumper Block for Alloy

Bumper Block 400m Long: Suits Alloy Rolla arms

Bumper Block W55 x H55 x 300L Grey

2888

2889

TRAILER EQUIPMENT

Beach Retrieving System.

Suits: All Dunbier Loader Series boat trailers.

Easy to fit just clamps on to the rear cross member.

Includes: L & R # 3106 Roller System 2 x # 3252 clamps.

3107

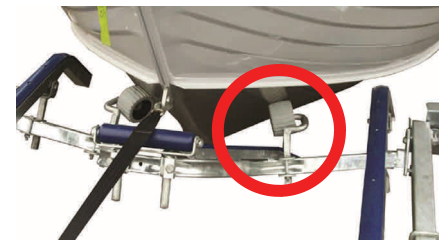

Glider Trailer Aftermarket Kit.

Suits: Most boat trailers complete as shown, Display boxed.

Kit assembly to suit 50 x 50mm cross member.

Kit assembly to suit 75 x 50mm cross member.

3108

3109

Please Note: Roller Rail & Keel Rollers Not Included

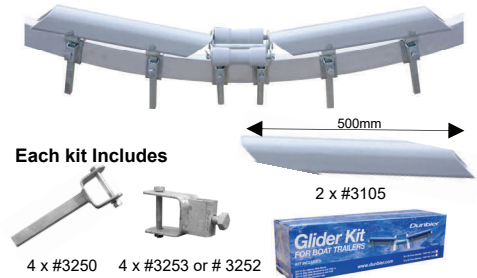

Centre Line Launch & Retrieve System.

Includes: 20mm square leg mount.

Suits: # 3252 slide frame mount.

Complete as shown display boxed.

3093



Universal Cross Member Plate With Ubolts.

Suits: 50 x 50mm tube.

Suits: 75 x 50mm tube.

Suits: 100 x 50mm tube.

3119

3120

3121



Two Hole Plate.

Suits: Any 12mm ubolt that fits over 50mm wide tube.

Size: 100 x 30 x 7mm suits ubolt centres 62mm.

3291



Roller Arm Bubble Plate Assembly

Suits: All steel roller arms complete as shown.

Suits: Alloy roller arms complete as shown.

3290

3290A



Supa-Rolla & Rolla-Matic Rear Angle Plates.

Galvanized and complete as shown.

3292



Steel And Plastic Pads.

50 x 50mm square galvanized tube: 3000mm long.

50 x 50mm square galvanized tube: 1330mm long.

50 x 50mm square galvanized tube: 1600mm long.

3352

3353

3354

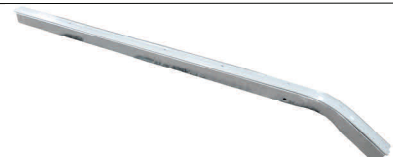

Steel And Plastic Pads: Suits Loader Trailers.

50 x 50mm square galvanized tube: 1330mm long.

50 x 50mm square galvanized tube: 1600mm long.

3365

3366



Carpet Pad Suits Water-Toy Trailers.

70 x 45mm timber with marine grade carpet: 1600mm long.

3359



TRAILER EQUIPMENT

	<p>Weld-On Frame "U" Bracket. Complete with 1/2" bolt and nut, suits 20mm square leg. Raw Metal Finish. # 3139 Galvanized Finish. # 3139G</p>
	<p>Bolt-On Frame "U" Bracket. Complete with galvanized 1/2" bolt and nut. Suits, 20mm square solid steel or tube (Bulk). # 3138B</p>
	<p>Slide Bracket. Complete with galvanized bolts and nuts. Fits 50 x 50mm square tube cross member (Bulk). # 3252 Suits: 20mm square solid steel or tube. (Display Pack). # 3252S</p>
	<p>Slide Bracket. Complete with galvanized bolts and nuts. Suits: 75 x 50mm tube cross member (Bulk). # 3253</p>
	<p>Slide Bracket. Complete with galvanized bolts and nuts. Fits 100 x 50mm tube cross member. Suits: 20mm square solid steel or tube. # 3254</p>
	<p>Heavy Duty Slide Bracket. Complete with galvanized bolts and nuts. Fits 50 x 50mm square tube cross member. Suits: 40mm square tube. # 3122</p>
	<p>Heavy Duty Slide Bracket. Complete with galvanized bolts and nuts. Fits 75 x 50mm cross members. Suits: 40mm square tube. # 3123</p>
	<p>Heavy Duty Slide Bracket. Complete with galvanized bolts and nuts. Fits: 50 x 50mm cross member with single frame bolt. Suits: 40mm square tube leg. # 3124</p>
	<p>Heavy Duty Slide Bracket. Complete with galvanized bolts and nuts. Fits: 100 x 50mm cross member with single lock bolt. Suits: 40mm square tube. # 3125</p>
	<p>Two Way Slide Bracket. Complete with galvanized bolts and nuts. Suits: 50 x 50mm square tube, both ways. # 3305</p>
	<p>Pad Brackets with 20mm Round Leg. Suits: 50mm square tube or timber pad etc. Leg length: 120mm with galvanized bolts and nuts. # 3304 Leg length: 190mm with galvanized bolts and nuts. # 3306</p>
	<p>Pad Brackets with 20mm Square Legs Leg length: 185mm and 42mm inside "U" bracket # 3250 Leg length: 185mm and 52mm inside "U" bracket # 3251 Leg length: 250mm and 52mm inside "U" bracket # 3251L</p>

TRAILER EQUIPMENT

Pad Brackets with 40mm Square Legs.

Leg length: 170mm and 52mm inside "U" bracket. # 3300
 Leg length: 250mm and 52mm inside "U" bracket. # 3300L



Pad Brackets Off Set with 40mm Square Legs

Leg length: 220mm and 52mm inside "U" bracket. # 3302



Pad Bracket Off Set with 20mm Round Leg.

Leg length: 120mm and 52mm inside "U" bracket. # 3307



Tube 40mm Square Leg.

Leg length: 265mm. # 3131



Supa-Rolla & Rolla-Matic Rear Cross Member.

Material size: 50mm sq, complete with adjustable stop.
 Suits: Dunbier standard frame width: 1465mm. # 3344
 Suits: Dunbier wide frame width: 1725mm. # 3344W



Supa-Rolla & Rolla-Matic Rear Swing Member.

Material size: 75 x 50mm, complete adjustable stop.
 Suits: Dunbier wide frame width: 1725mm. # 3345



Loader Rear Swing Cross Member.

Material size: 50mm sq, suits trailers from October 2005.
 Suits: Dunbier frame width: 1465mm # 3343
 Suits: Dunbier wide frame width: 1725mm # 3343W



Replacement Galvanized Supa-Rolla Cross Members.

W1365 x D50 x 50mm. # 3326
 W1625 x D50 x 50mm # 3328
 W1625 x D75 x 50mm # 3329



Replacement Galvanized "V" Cross Members.

Shallow "V" W1365 x D50 x 50mm. # 3325
 Shallow "V" W1625 x D50 x 50mm # 3327



Rear Swing Cross Member Stop.

Replacement Ubolt only 67 x 60 x 12mm # 2121
 Complete with Ubolt as shown. # 3341



Winch Post Plastic Caps.

50mm Square slant top. # 3452
 50mm Square flat top (Import) # 3456
 Suits: 64mm Square. slant top # 3453
 Suits: 100mm Square flat top # 3454

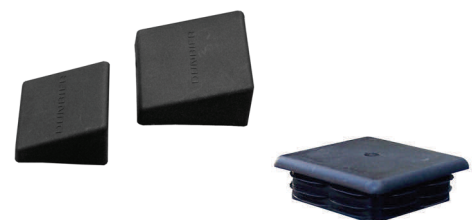

TRAILER EQUIPMENT



Trailer Winch Post.

Suits: Double Water-Toy Trailer.
Galvanized 50 x 50mm square tube.

3441



Trailer Winch Post.

Galvanized 630 x 50 x 50mm square tube.
Dunbier Trailers to 5.0M, base plate suits 76mm wide drawbar.
Base plate Suits: 50mm wide drawbar.

3448

3440



Trailer Winch Post.

Galvanized 690 x 64 x 64mm square tube.
Suits: Dunbier Trailers from 5.3– 6.2M.
Base plate Suits: 100mm wide drawbar.

3449



Trailer Winch Post.

Galvanized 690 x 64 x 64mm square tube.
Suits: Dunbier Trailers from 4.4– 5.0M.
Base plate Suits: 76mm wide drawbar.

3450



Trailer Winch Post.

Galvanized 700 x 100 x 100mm square tube.
Suits: Dunbier Trailers from 6.6M.
Base plate Suits: 100mm wide drawbar.

3451



Fold-A-Way Trailer Winch Post.

Galvanized 50 x 50mm square tube.
Suits: Dunbier Trailer Fold-A-Way
Base plate Suits: 50mm wide drawbar.

3439



Trailer Winch Carrier.

Galvanized and suits 50 x 50mm square tube.
Suits: Dunbier Foldaway Trailer.

3455



Trailer Winch Carrier.

Galvanized and suits 50 x 50mm square tube.
Suits: Dunbier Trailers 3.7- 4.3M.

3480



Trailer Winch Carrier.

Galvanized and suits 64 x 64mm square tube.
Suits: Dunbier Trailers 4.4– 6.2M.

3490



Trailer Winch Carrier.

Galvanized and suits 100 x 100mm square tube.
Suits: Dunbier Trailers 6.6– 8.0M.

3492



Electric Winch Carrier

Longer winch carrier to suit electric winches.
Suits 100 x 100mm square winch post.
Suits: 64 x 64 square winch post.

3499

3500



Water Vehicle Trailer Winch Carrier

Galvanized and suits 50 x 50mm square winch post.
Suits: All Dunbier Water-Toy Series Trailers.

3464

TRAILER EQUIPMENT

Water Vehicle Trailer Winch Carrier

Double roller and suits 50 x 50mm square winch post.

Suits: All Dunbier Water-Toy Series Trailers.

Does not include winch.

3465



Trailer Winch Carrier

Large nose roller and suits 100 x 100mm square winch post.

Suits: Dunbier Alloy Series Trailers.

Does not include winch.

3463

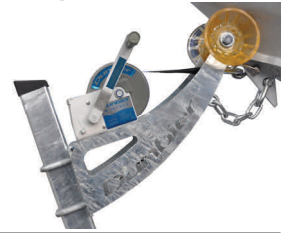

Water-Toy Winch Carrier & Post

Small poly bow roller suits 75 x 75mm square winch post.

Suits: #9165P & #9169P Jet Ski Trailers

Does not include winch.

3466



Drawbar Keel Support For kayaks.

Fits forward of the drawbar "V" suits most kayaks.

Suits: 75mm Sq tube, complete with rubber v block & Ubolt

3133



Swing Drawbar DIY Kit.

Raw metal finish & engineered for trailers with GVM to 3.5 tonne.

The kit needs welding on installation by a professional welding person complete with drop pin as shown

Suits: 76mm square drawbar.

3945

Suits: 100mm square drawbar.

3946

Replacement Swing Drawbar Drop Pin

3954



Battery Box's Including Straps.

Made from rigid polypropylene.

Small L270 x W185 x H195mm.

5451

Large L335 x W185 x H225mm.

5452

Extra Large: L395 x W185 x H197mm.

5449



Battery Box Replacement Strap.

Replacement strap to suit: # 5451, # 5452 & # 5449.

5450



Trailer "D" Shackles.

10 mm L58 x W37 x 19 inside x 10mm (Bulk).

5632B

10 mm L58 x W37 x 19 inside x 10mm (Display Pack).

5632C

12 mm L70 x W47 x 27 inside x 12mm (Bulk)

5633

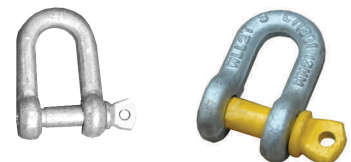

Rated Trailer D Shackle

10mm Rated D Shackles

5630

12mm Rated D Shackles

5672

RATED SHACKLES

"R" Clips.

Small "R" Clip L44 x W14 x 2mm (Bulk)

8974

Small "R" Clip L65 x W22 x 3mm (Bulk).

8999

Medium "R" Clip L76 x W25 x 4mm(Bulk).

1360

Medium "R" Clip (sold in pairs and display packed).

1360C

Large "R" Clip L118 x W42 x 6mm (Bulk).

8950



TRAILER EQUIPMENT

FOLDAWAY TRAILERS

NEW ALLOY FOLDAWAY
#9001A



GALVANIZED FOLDAWAY
#9001



30Kgs



SPECIFICATIONS

	Galvanized	Alloy
Width	1360	1360
Tare Mass	63kg	45kg
Gross Trailer Mass	250kg	
Trailer Part Number	#9001	

Popular Spare Parts

- # 1449 Wheel & Tyre 8"
- # 1652 Hub with bearing set
- # 2231 Mudguard & stub axle assembly

The Fold-A-Way trailer intended design is to be transported folded up in a caravan or vehicle, then at the final destination to assemble, fit the boat to the trailer then tow a short distance to the water. The trailer is not manufactured for long highway use or continuous towing over rough terrain.

PLEASE NOTE: The Fold-A-Way trailer has been designed with no springing to achieve a portable trailer for easy use. Common sense must be prevail in regards to towing speeds on highways and particular unmade roads.

TRAILER PACK RACK



Leave nothing behind again. Free up the boot of your car with this fully galvanized Pack Rack, perfect for that great day out on the water. The Trailer Pack Rack is both Strong and Stable, designed to be easily installed, suits Dunbier Water Toy, Nipper and Sports Series and most other brands of small boat trailers.

TRAILER EQUIPMENT



Side Frame Stickers

- Large side frame sticker, suits 100mm depth. # 8104
- Small side frame sticker, suits 75mm depth. # 8103



Mudguard Stickers

- Sold in pairs. # 8105



NEW

Dunbier Sticker Kit

Includes 2 side frame long stickers and 2 mudguard small stickers.

- Suits Trailers up to 5.0M # 8113
- Suits Trailers from 5.3M # 8114

BOLTS, NUTS & WASHERS



Description	
# 8890	M12 x 130 Zinc High Tensile Bolt/Nylock Nut
# 8891	M12 x 140 Zinc High Tensile Bolt/Nylock Nut
# 8892	M12 x 150 Zinc High Tensile Bolt/Nylock Nut
# 8893	M12 x 170 Zinc High Tensile Bolt/Nylock Nut
# 8901	1 1/4" x 1/2" Galvanized Bolt only (Hard Point).
# 8902	2" x 3/16" Galvanized Bolt only.
# 8903	2 1/4 x 7/16" Zinc Bolt Only (Caliper Mount).
# 8904	1" x 1/4" Galvanized Bolt Only.
# 8905	M10 x 25 Galvanized Bolt & Nut.
# 8906	M10 x 40 Galvanized Bolt & Nut.
# 8907	M10 x 65 Galvanized Bolt & Nut.
# 8908	M10 x 75 Galvanized Bolt & Nut.
# 8909	M10 x 100 Galvanized Bolt & Nut.
# 8910	M10 x 130 Galvanized Bolt & Nut
# 8911	M12 x 90 Galvanized Bolt & Nut.
# 8912	M12 x 140 Galvanized Bolt & Nut.
# 8913	M12 x 170 Galvanized Bolt & Nut.
# 8915	M12 x 120 Galvanized Bolt & Nut.
# 8916	M12 x 110 Galvanized Bolt & Nut.
# 8917	M20 x 130 Galvanized Bolt Only.
# 8918	M12 x 130 Galvanized Bolt & Nut
# 8919	M20 x 150 Galvanized Bolt Only.
# 8920	1/4" Nylock Nut Galvanized.
# 8921	5/8" Nylock Nut Zinc Plated.

Description	
# 8922	1/2" Galvanized Nut Only.
# 8923	M10 Galvanized Nut Only.
# 8924	M12mm Galvanized Nut Only.
# 8925	M16 Galvanized Nut Only.
# 8926	M20 Nylock Nut Zinc Plated.
# 8927	3/16" Nylock Nut Galvanized.
# 8928	M10 Galvanized Nylock Nut.
# 8929	M12 Galvanized Nylock Nut.
# 8930	M16 Galvanized Nylock Nut.
# 8931	M12 Galvanized Flat Washer.
# 8932	M20 Zinc Flat Washer (Axle washer).
# 8933	M20 Galvanized Flat Washer.
# 8934	M12 Shake proof Washer.
# 8935	1/2" & 12mm Galvanized Spring Washer.
# 8936	M10 Galvanized Spring Washer.
# 8938	M10 x 60 Galvanized Coach Bolt & Nut
# 8939	M12 x 200 Galvanized Bolt & Nut.
# 8940	M12 x 240 Galvanized Bolt & Nut.
# 8941	1/4" x 1 1/4" Galvanized Bolt & Nut.
# 8957	M16 x 110 Galvanized Bolt & Nut.
# 8962B	7/16" Zinc Flat Washer
# 8963B	7/16" Zinc Spring Washer
# 8964	M20 Flat Black Washer
# 8976	M20 x 120 Zinc Plated Bolt & Nut